

User's Manual



USP 405

Universal Signal Processor

Precautions

Safety Instructions • English



This symbol is intended to alert the user of important operating and maintenance (servicing) instructions in the literature provided with the equipment.



This symbol is intended to alert the user of the presence of uninsulated dangerous voltage within the product's enclosure that may present a risk of electric shock.

Caution

Read Instructions • Read and understand all safety and operating instructions before using the equipment.

Retain Instructions • The safety instructions should be kept for future reference.

Follow Warnings • Follow all warnings and instructions marked on the equipment or in the user information.

Avoid Attachments • Do not use tools or attachments that are not recommended by the equipment manufacturer because they may be hazardous.

Consignes de Sécurité • Français



Ce symbole sert à avertir l'utilisateur que la documentation fournie avec le matériel contient des instructions importantes concernant l'exploitation et la maintenance (réparation).



Ce symbole sert à avertir l'utilisateur de la présence dans le boîtier de l'appareil de tensions dangereuses non isolées posant des risques d'électrocution.

Attention

Lire les instructions • Prendre connaissance de toutes les consignes de sécurité et d'exploitation avant d'utiliser le matériel.

Conservier les instructions • Ranger les consignes de sécurité afin de pouvoir les consulter à l'avenir.

Respecter les avertissements • Observer tous les avertissements et consignes marqués sur le matériel ou présentés dans la documentation utilisateur.

Éviter les pièces de fixation • Ne pas utiliser de pièces de fixation ni d'outils non recommandés par le fabricant du matériel car cela risquerait de poser certains dangers.

Sicherheitsanleitungen • Deutsch



Dieses Symbol soll dem Benutzer in der im Lieferumfang enthaltenen Dokumentation besonders wichtige Hinweise zur Bedienung und Wartung (Instandhaltung) geben.



Dieses Symbol soll den Benutzer darauf aufmerksam machen, daß im Inneren des Gehäuses dieses Produktes gefährliche Spannungen, die nicht isoliert sind und die einen elektrischen Schock verursachen können, herrschen.

Achtung

Lesen der Anleitungen • Bevor Sie das Gerät zum ersten Mal verwenden, sollten Sie alle Sicherheits- und Bedienungsanleitungen genau durchlesen und verstehen.

Aufbewahren der Anleitungen • Die Hinweise zur elektrischen Sicherheit des Produktes sollten Sie aufbewahren, damit Sie im Bedarfsfall darauf zurückgreifen können.

Befolgen der Warnhinweise • Befolgen Sie alle Warnhinweise und Anleitungen auf dem Gerät oder in der Benutzerdokumentation.

Keine Zusatzgeräte • Verwenden Sie keine Werkzeuge oder Zusatzgeräte, die nicht ausdrücklich vom Hersteller empfohlen wurden, da diese eine Gefahrenquelle darstellen können.

Instrucciones de seguridad • Español



Este símbolo se utiliza para advertir al usuario sobre instrucciones importantes de operación y mantenimiento (o cambio de partes) que se desean destacar en el contenido de la documentación suministrada con los equipos.



Este símbolo se utiliza para advertir al usuario sobre la presencia de elementos con voltaje peligroso sin protección aislante, que puedan encontrarse dentro de la caja o alojamiento del producto, y que puedan representar riesgo de electrocución.

Precaucion

Leer las instrucciones • Leer y analizar todas las instrucciones de operación y seguridad, antes de usar el equipo.

Conservar las instrucciones • Conservar las instrucciones de seguridad para futura consulta.

Obedecer las advertencias • Todas las advertencias e instrucciones marcadas en el equipo o en la documentación del usuario, deben ser obedecidas.

Evitar el uso de accesorios • No usar herramientas o accesorios que no sean específicamente recomendados por el fabricante, ya que podrían implicar riesgos.

Warning

Power sources • This equipment should be operated only from the power source indicated on the product. This equipment is intended to be used with a main power system with a grounded (neutral) conductor. The third (grounding) pin is a safety feature, do not attempt to bypass or disable it.

Power disconnection • To remove power from the equipment safely, remove all power cords from the rear of the equipment, or the desktop power module (if detachable), or from the power source receptacle (wall plug).

Power cord protection • Power cords should be routed so that they are not likely to be stepped on or pinched by items placed upon or against them.

Servicing • Refer all servicing to qualified service personnel. There are no user-serviceable parts inside. To prevent the risk of shock, do not attempt to service this equipment yourself because opening or removing covers may expose you to dangerous voltage or other hazards.

Slots and openings • If the equipment has slots or holes in the enclosure, these are provided to prevent overheating of sensitive components inside. These openings must never be blocked by other objects.

Lithium battery • There is a danger of explosion if battery is incorrectly replaced. Replace it only with the same or equivalent type recommended by the manufacturer. Dispose of used batteries according to the manufacturer's instructions.

Avertissement

Alimentations • Ne faire fonctionner ce matériel qu'avec la source d'alimentation indiquée sur l'appareil. Ce matériel doit être utilisé avec une alimentation principale comportant un fil de terre (neutre). Le troisième contact (de mise à la terre) constitue un dispositif de sécurité : n'essayez pas de le contourner ni de le désactiver.

Déconnexion de l'alimentation • Pour mettre le matériel hors tension sans danger, déconnectez tous les cordons d'alimentation de l'arrière de l'appareil ou du module d'alimentation de bureau (s'il est amovible) ou encore de la prise secteur.

Protection du cordon d'alimentation • Acheminer les cordons d'alimentation de manière à ce que personne ne risque de marcher dessus et à ce qu'ils ne soient pas écrasés ou pincés par des objets.

Réparation-maintenance • Faire exécuter toutes les interventions de réparation-maintenance par un technicien qualifié. Aucun des éléments internes ne peut être réparé par l'utilisateur. Afin d'éviter tout danger d'électrocution, l'utilisateur ne doit pas essayer de procéder lui-même à ces opérations car l'ouverture ou le retrait des couvercles risquent de l'exposer à de hautes tensions et autres dangers.

Fentes et orifices • Si le boîtier de l'appareil comporte des fentes ou des orifices, ceux-ci servent à empêcher les composants internes sensibles de surchauffer. Ces ouvertures ne doivent jamais être bloquées par des objets.

Lithium Batterie • Il a danger d'explosion s'il y a un remplacement incorrect de la batterie. Remplacer uniquement avec une batterie du même type ou d'un type équivalent recommandée par le constructeur. Mettre au rebut les batteries usagées conformément aux instructions du fabricant.

Vorsicht

Stromquellen • Dieses Gerät sollte nur über die auf dem Produkt angegebene Stromquelle betrieben werden. Dieses Gerät wurde für eine Verwendung mit einer Hauptstromleitung mit einem geerdeten (neutralen) Leiter konzipiert. Der dritte Kontakt ist für einen Erdanschluß, und stellt eine Sicherheitsfunktion dar. Diese sollte nicht umgangen oder außer Betrieb gesetzt werden.

Stromunterbrechung • Um das Gerät auf sichere Weise vom Netz zu trennen, sollten Sie alle Netzkabel aus der Rückseite des Gerätes, aus der externen Stromversorgung (falls dies möglich ist) oder aus der Wandsteckdose ziehen.

Schutz des Netzkabels • Netzkabel sollten stets so verlegt werden, daß sie nicht im Weg liegen und niemand darauf treten kann oder Objekte darauf- oder unmittelbar dagegengestellt werden können.

Wartung • Alle Wartungsmaßnahmen sollten nur von qualifiziertem Servicepersonal durchgeführt werden. Die internen Komponenten des Gerätes sind wartungsfrei. Zur Vermeidung eines elektrischen Schocks versuchen Sie in keinem Fall, dieses Gerät selbst öffnen, da beim Entfernen der Abdeckungen die Gefahr eines elektrischen Schlags und/oder andere Gefahren bestehen.

Schlitze und Öffnungen • Wenn das Gerät Schlitze oder Löcher im Gehäuse aufweist, dienen diese zur Vermeidung einer Überhitzung der empfindlichen Teile im Inneren. Diese Öffnungen dürfen niemals von anderen Objekten blockiert werden.

Lithium-Batterie • Explosionsgefahr, falls die Batterie nicht richtig ersetzt wird. Ersetzen Sie verbrauchte Batterien nur durch den gleichen oder einen vergleichbaren Batterietyp, der auch vom Hersteller empfohlen wird. Entsorgen Sie verbrauchte Batterien bitte gemäß den Herstelleranweisungen.

Advertencia

Alimentación eléctrica • Este equipo debe conectarse únicamente a la fuente/tipo de alimentación eléctrica indicada en el mismo. La alimentación eléctrica de este equipo debe provenir de un sistema de distribución general con conductor neutro a tierra. La tercera pata (puesta a tierra) es una medida de seguridad, no puentearla ni eliminarla.

Desconexión de alimentación eléctrica • Para desconectar con seguridad la acometida de alimentación eléctrica al equipo, desenchufar todos los cables de alimentación en el panel trasero del equipo, o desenchufar el módulo de alimentación (si fuera independiente), o desenchufar el cable del receptáculo de la pared.

Protección del cables de alimentación • Los cables de alimentación eléctrica se deben instalar en lugares donde no sean pisados ni apretados por objetos que se puedan apoyar sobre ellos.

Reparaciones/mantenimiento • Solicitar siempre los servicios técnicos de personal calificado. En el interior no hay partes a las que el usuario deba acceder. Para evitar riesgo de electrocución, no intentar personalmente la reparación/mantenimiento de este equipo, ya que al abrir o extraer las tapas puede quedar expuesto a voltajes peligrosos u otros riesgos.

Ranuras y aberturas • Si el equipo posee ranuras o orificios en su caja/alojamiento, es para evitar el sobrecalentamiento de componentes internos sensibles. Estas aberturas nunca se deben obstruir con otros objetos.

Batería de litio • Existe riesgo de explosión si esta batería se coloca en la posición incorrecta. Cambiar esta batería únicamente con el mismo tipo (o su equivalente) recomendado por el fabricante. Desachar las baterías usadas siguiendo las instrucciones del fabricante.

Quick Start — USP 405

Installation

Step 1

Turn off power to the USP 405 and the input and output devices, and remove the power cords.

Step 2

Install the four rubber feet on the bottom of the USP 405, or mount the USP in a rack.

Step 3

Attach input devices to the USP.

Rear panel video inputs

Input 1: RGB with buffered local monitor

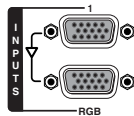

Input 2: RGB, component video, S-video, or composite video

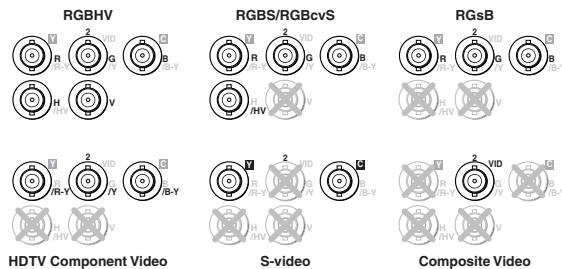

Inputs 3: composite video

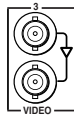

Input 4: S-video

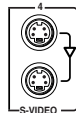

Input 5 (optional): SDI (serial digital interface)
Attach an SDI source to this BNC.



Step 4

Attach output devices to the USP 405.

Rear panel video outputs

Composite video (VID) output



Component video (R-Y, B-Y, Y) output

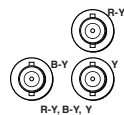

SDI video (serial digital interface) output (optional)



S-video output



RGB or component video output



RGB or HD component video output

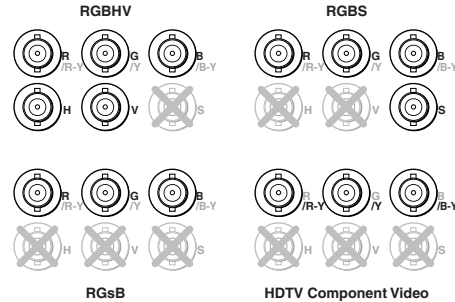

NOTE You can connect both outputs shown above (15-pin HD connector and the BNCs) simultaneously to two different displays. The sync format is the same for both outputs.

Step 5

Plug the USP 405 and the input and output devices into a grounded AC source, and turn on the input and output devices.

Step 6

Use the LCD menu screens (see the next page) or RS-232 programming to configure the USP 405. See chapter two for installation and operation procedures, and see chapter three for programming information.

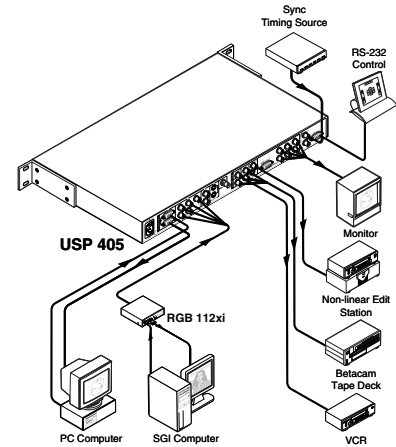

Application example with USP 405 being used as a scan converter

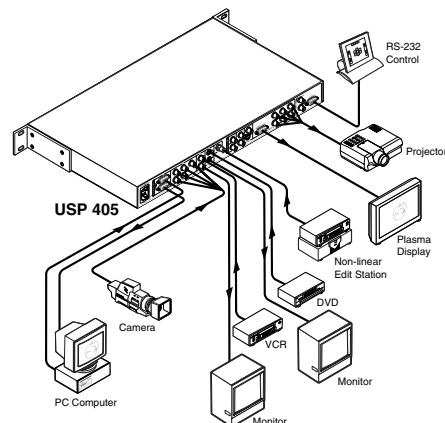

Application example with USP 405 being used as a scaler

Quick Start — USP 405, cont'd

USP 405 Menu System

Default Cycle menu

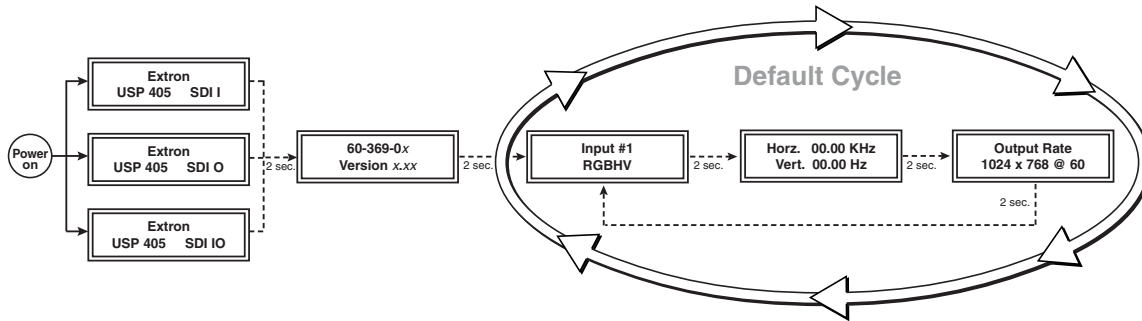

Main menu

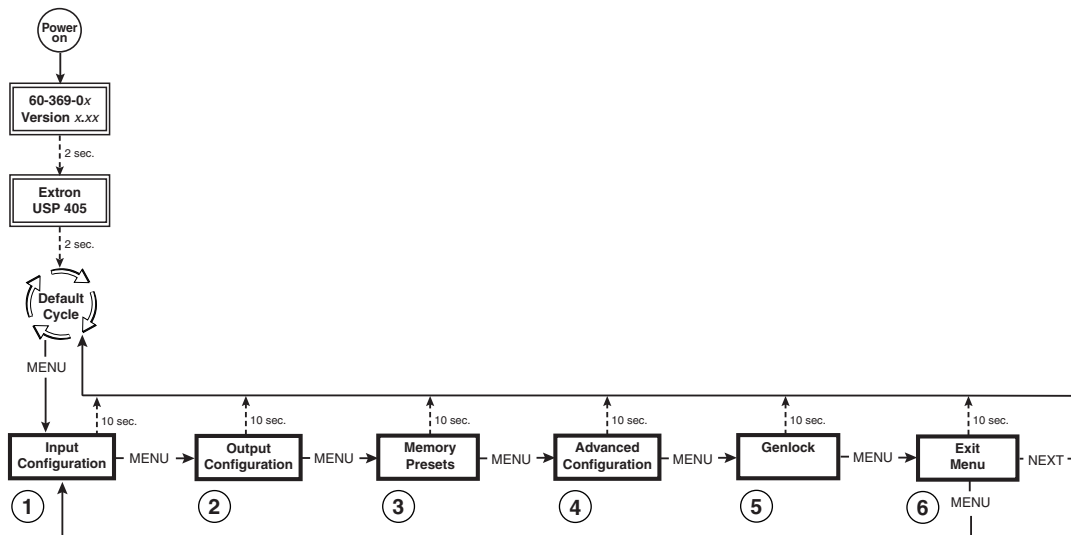

1 Input menu

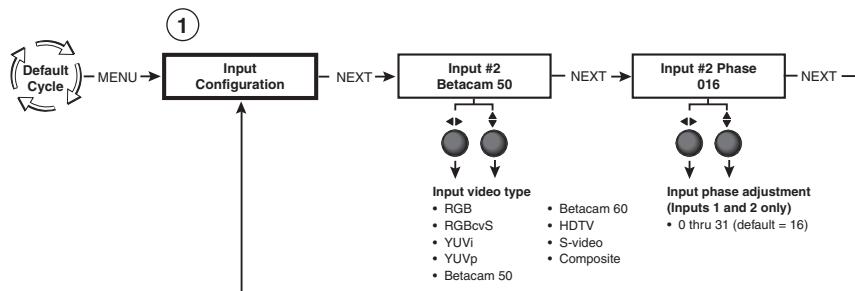

2 Output menu

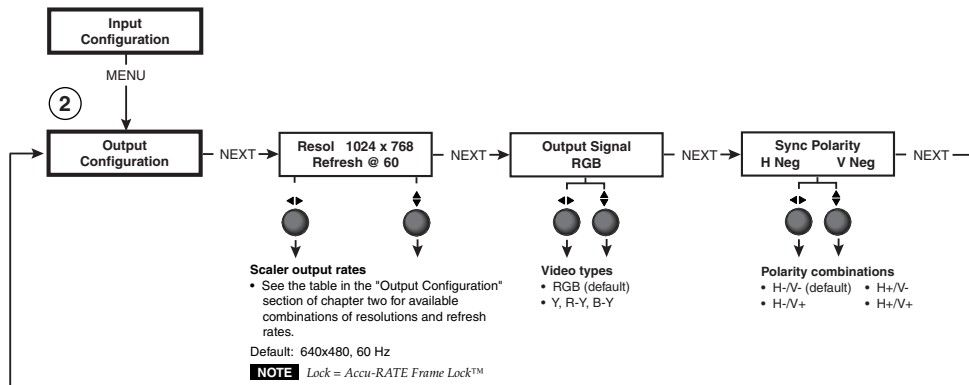

3 Memory Presets menu

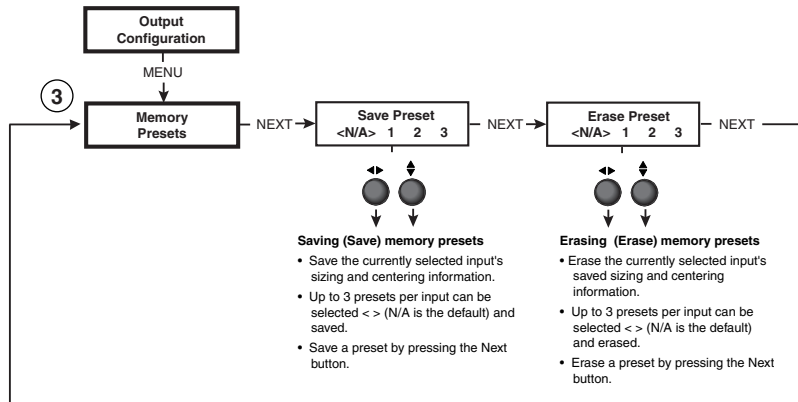

4 Advanced Configuration menu

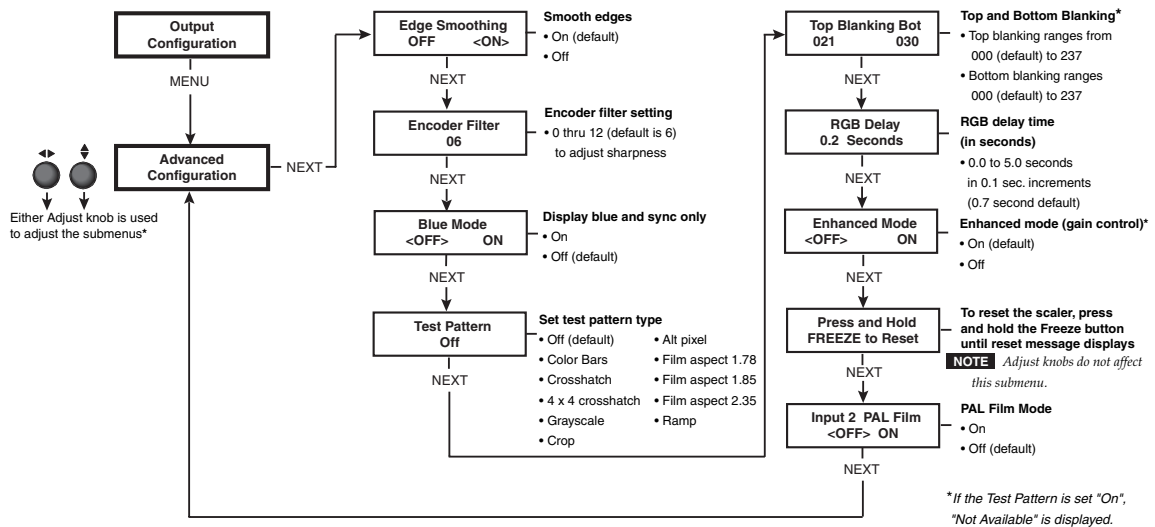

Quick Start — USP 405, cont'd

5 Genlock menu

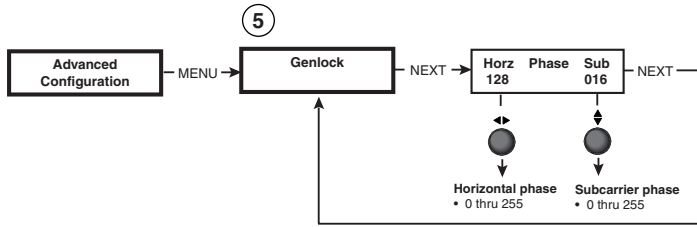

6 Exit menu

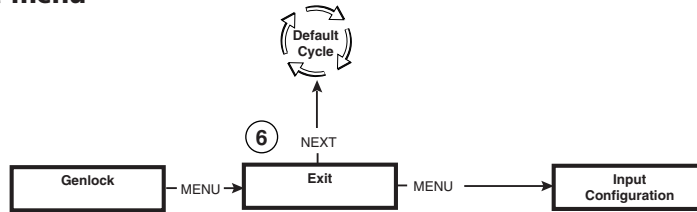

Picture Adjustments menu

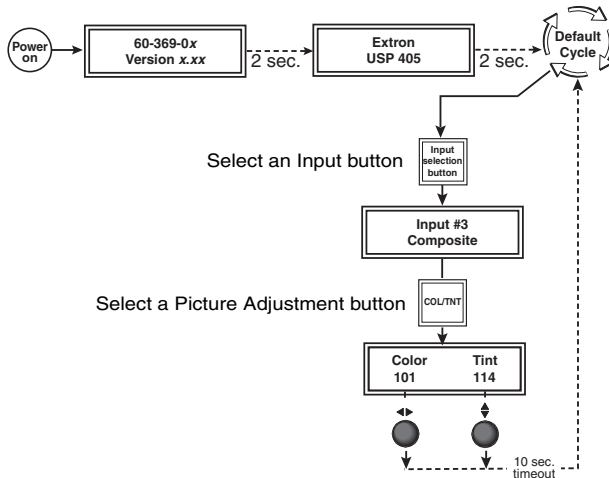

- NOTE** With an input signal present, the following picture adjustment(s) are "Not Available" for the respective inputs with exceptions in ():
- Input 1:** color and tint (not available anytime)
 - Input 2:** tint (but available only if S-video or composite is selected and NTSC signal is input)
 - Input 3:** tint (but available only if an NTSC signal is input)
 - Input 4:** tint (but available only if an NTSC signal is input)
 - Input 5:** color, tint, and detail

NOTE If the Test Pattern submenu in the Advanced Configuration menu has been set to any pattern other than "Off", "Crop", or a "Film aspect" crop pattern, the picture control adjustments will be disabled ("Not Available").

NOTE The horizontal Adjust knob and the vertical Adjust knob are used to adjust the image settings on the left and right sides of the LCD screen, respectively.

Executive Mode menu

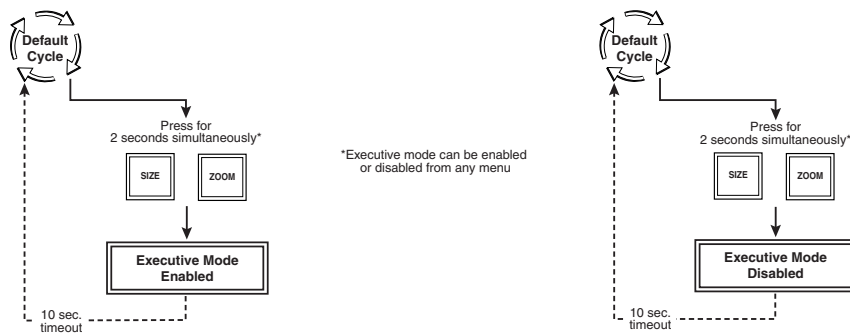

Optimizing the Image for High Resolution Outputs

Step 1

Set the USP to output the crop pattern, then use the *display's* positioning controls to position the image so that you can see all sides on the display. To select the crop pattern:

See "Test Pattern submenu" (page 2-17).

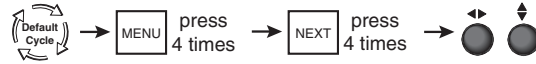

Step 2

If you are using a digital display, use the alternating pixels test pattern as a reference to adjust the phase and dot clock on the display device. To select the alternating pixels test pattern:

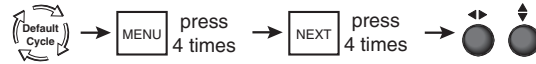

Step 3

Select an input. Set the test pattern either to crop (if the source is 4:3, see step 2 above) or to the appropriate aspect ratio test pattern. Use the USP's sizing and centering functions to fill the pattern. To set the sizing or centering:



NOTE If the source is a DVD, set the DVD player to output a 16:9 aspect ratio prior to performing step 4.

See "Image Adjustments" (page 2-19).

Step 4

For RGB input sources (Inputs 1 and 2), HDTV, and YUVp (input 2), use phase adjustments to eliminate noise. To adjust pixel phase:

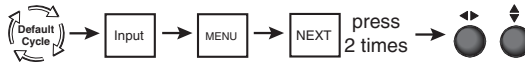

Step 5

For the RGB input sources (Inputs 1 and 2), use the horizontal and vertical detail adjustments to increase the sharpness. To adjust the horizontal and vertical filtering:

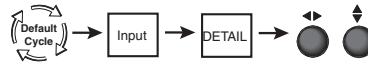

See "Image Adjustments" (page 2-19).

NOTE For composite, S-video, and YUV inputs, the horizontal and vertical filtering adjustments are replaced with a detail (sharpness) adjustment.

Step 6

For all inputs, set brightness and contrast levels. To adjust brightness and contrast:

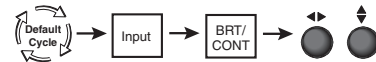

See "Image Adjustments" (page 2-19).

NOTE Once the sizing, centering, and filtering adjustments are complete, proceed to the next step.

Step 7

For composite video (input 3) and S-video (input 4) inputs, set the USP to output blue-only video and input color bars into the USP. Using the blue color bars as a reference, use the USP's color and tint controls to adjust the video's color and tint. To select blue-only video:

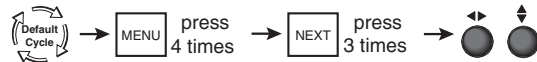

See "Blue Mode submenu" (page 2-17).

To adjust color and tint:

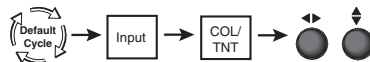

See *Image Adjustments* (page 2-19).

Step 8

Save this setting into one of the input's three user memories. To save the setting to memory:

See "Memory Presets" (page 2-15).

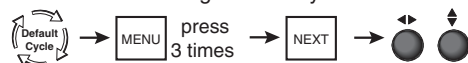

Quick Start — USP 405, cont'd

Optimizing the Image for Standard Resolution Outputs (NTSC/PAL rates)

Step 1

If you are using an analog CRT display, use the crosshatch test pattern as a reference to converge the display. To select the crosshatch pattern:

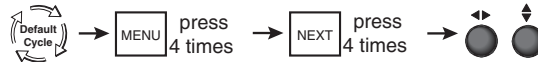

See "Test Pattern submenu" (page 2-17).

Step 2

Set the USP to output the crop pattern, then use the *display's* positioning controls to position the image so that you can see all sides on the display. To select the crop pattern:

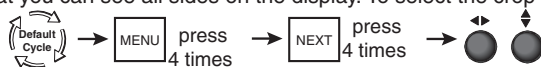

NOTE At this point, sizing and centering on the display is complete.

Step 3

Select an input. Set the test pattern either to crop (if the source is 4:3, see step 2 above), or to the appropriate aspect ratio test pattern. Use the USP's sizing and centering functions to fill the pattern. To set the sizing or centering:



See "Image Adjustments" (page 2-19).

NOTE If the source is a DVD, set the DVD player to output a 16:9 aspect ratio prior to performing step 4.

Step 4

For the RGB input sources (Inputs 1 and 2), use the source material that is to be displayed.

a. Use phase adjustment to reduce noise and achieve a clear and sharp image. To adjust pixel phase:



b. Use the horizontal filter adjustment to maximize the amount of detail and the vertical filter adjustment to reduce the amount of flicker on the screen. To adjust the horizontal and vertical filtering:

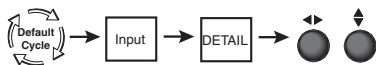

NOTE For composite, S-video, and YUV inputs, the horizontal and vertical filtering adjustments are replaced with a detail (sharpness) adjustment.

See "Image Adjustments" (page 2-19).

c. Next, use the encoder filter to adjust the sharpness of the image to the desired level. To adjust the sharpness:



See "Encoder Filter submenu" (page 2-17).

Step 5

For composite, S-video, and component video inputs use the detail setting to adjust the sharpness of the image. To adjust the image detail, see step 4a above.

Step 6

Save this setting into one of the input's three user memories. To save the setting to memory:



See "Memory Presets" (page 2-15).

Table of Contents

Chapter 1 • Introduction	1-1
About this Manual	1-2
About the USP 405	1-2
What is the USP 405?	1-2
Controlling the USP 405 digital video scaler	1-2
Features and Options	1-2
Features	1-2
Options and accessories	1-4
Chapter 2 • Installation and Operation	2-1
Mounting the Scaler	2-2
Tabletop use	2-2
Rack mounting	2-2
Application diagrams	2-2
Rear Panel Features	2-4
Power connection	2-4
Video input and output connections	2-4
Genlock connections	2-6
RS-232 connection	2-6
Front Panel Features	2-6
Input selection buttons	2-7
Picture adjustment buttons	2-7
LCD menu display and controls	2-8
Genlock and Vertical Interval Switching	2-8
Genlock setup	2-8
Oscilloscope displays	2-10
Optimizing the System	2-11
Setting up a DVD source	2-11
Menus, Configuration, and Adjustments	2-12
Moving through menus by using front panel controls	2-12
Menu overview	2-12
Input Configuration	2-13
Input #2 submenu	2-14
Input Phase submenu	2-14
Output Configuration	2-14
Resolution and refresh rates submenu	2-14
Output Signal (RGB format) submenu	2-15
Sync Polarity submenu	2-15
Memory Presets	2-15
Save memory presets submenu	2-15
Erase memory presets submenu	2-16
Recalling a preset	2-16
Advanced Configuration	2-17
Edge smoothing submenu	2-17
Encoder filter submenu	2-17
Blue mode submenu	2-17
Test pattern submenu	2-17

Table of Contents, cont'd

Top and bottom blanking submenu	2-18
RGB Delay (Triple-Action Switching™) submenu	2-18
Enhanced mode submenu	2-18
PAL Film mode detect (2:2 pulldown detection) submenu	2-18
Reset submenu	2-18
Genlock menu	2-18
Exit menu	2-19
Image Adjustments	2-19
Color, tint, brightness, contrast, detail, sizing, zoom, centering	2-19
Front Panel Security Lockout (Executive mode)	2-20
IR 801 Infrared Remote Control	2-21
Selecting an input	2-21
Freezing an input	2-21
Aspect ratio presets	2-21
Horizontal and vertical filtering	2-22
Adjusting image size	2-22
Shifting the image	2-22
Image adjustments	2-22
Troubleshooting	2-22
Operating problems	2-23
Chapter 3 • Serial Communication	3-1
RS-232 Programmer's Guide	3-2
Host-to-signal processor communications	3-2
Signal processor-initiated messages	3-2
Error responses	3-2
Symbol definitions	3-3
Using the command/response tables	3-3
Command/response table for SIS commands	3-4
Command/response table for special function SIS commands	3-7
Control Software for Windows	3-8
Installing the software	3-8
Using the control program	3-8
Using the help program	3-9
Labeling Buttons on the USP 405	3-9
Button-Label Generator software	3-9
Installing the software	3-9
Using the software	3-9
Installing labels in the USP 405's buttons	3-10
Setting the Output Rate Using the Per Input Feature	3-11
Appendix A • Appendix	A-1
Specifications	A-2
Part Numbers and Accessories	A-4
Included parts	A-4
Accessories	A-4

Firmware Upgrade Installation	A-5
Serial Digital Interface (SDI) Card Installation	A-7

All trademarks mentioned in this manual are the properties of their respective owners.

Table of Contents, cont'd



USP 405

Chapter One

Introduction

About this Manual

About the USP 405

Features and Options

Introduction

About this Manual

This manual discusses how to install, configure, and operate the Extron USP 405 universal signal processor and how to operate the optional IR 801 infrared remote control (part #70-152-01).

Throughout this manual the terms “USP”, “universal signal processor”, and “signal processor” are used interchangeably to refer to the same product.

About the USP 405

What is the USP 405?

The USP 405 is a high performance digital video scaler, scan converter, standards converter, and transcoder. It accepts a wide range of video input signals and converts them, up or down, into a number of different signal formats to meet the video requirements of virtually any system. The USP 405 offers 35 output rates, including HDTV, and provides scaling solutions for boardrooms and conference rooms, as well as rental and staging applications.

The USP 405 is available in four configurations: a basic model (part #60-369-01), which does not include the serial digital interface (SDI); a model that includes SDI input (part #60-369-02); a model that includes SDI output (part #60-369-03); and a model that includes both SDI input and SDI output (part #60-369-04).

The USP accepts computer video (RGB), component video, S-video, composite video, and SDI input (optional).

To enable superior scaling performance, the USP 405 features several of Extron’s patent-pending technologies, including Dynamic Motion Interpolation (DMI™), and 3:2 and 2:2 pulldown detection. DMI is an advanced motion detection and compensation method that enables image enhancement with no loss of image fidelity.

Controlling the USP 405 universal signal processor

The USP 405 can be controlled using one or more of the following means:

- The front panel controls
- A computer, a third party control system, or any other device that can send and receive the serial communications through the RS-232 port. Extron’s Simple Instruction Set™ (SIS™) is a set of simple keystroke commands that can be used with any such devices, and Extron’s control software for Windows provides a graphical interface for controlling the signal processor from a computer.
- The optional IR 801 remote control, which has most of the front panel controls
- Contact closure control

Features and Options

Features

Six video inputs —

- **Input 1** — One 15-pin HD connector for RGB/computer video input, and one 15-pin HD connector for a buffered local monitor output
- **Input 2** — Five BNC connectors accept RGBHV/RGBS/RGSB computer video, RGBcvS, component video, S-video, or composite video.
- **Input 3** — One BNC connector accepts composite video signals, and one BNC connector outputs a buffered loop-through composite video signal.

-
- **Input 4** — One 4-pin mini-DIN connector accepts S-video, and one mini-DIN connector outputs a buffered loop-through S-video signal.
 - **Input 5 (optional)** — One BNC connector inputs the optional SDI (serial digital interface) signal.

Six video outputs —

- **Composite video** — One BNC connector for composite video
- **Component video** — Three BNC connectors for R-Y, B-Y, Y
- **SDI video (optional)** — One BNC connector for serial digital interface (optional)
- **S-video** — One 4-pin mini-DIN connector for S-video
- **RGB video** — One 15-pin HD connector for RGB/computer video
- **RGB/HDTV video** — Five BNC connectors for HDTV R-Y, B-Y, Y (component) video

Four ways to control the USP 405 — The USP's front panel, a computer or other RS-232 control device, the optional IR 801 remote control, or contact closure control can all be used to control the USP.

Scaled outputs — The USP 405 offers 35 different output rates.

RS-232 configuration — The USP 405 can be configured by using the Extron control software for Windows, or by using a third party control system.

Freeze button — Each input of the USP 405 can be frozen using the Freeze button. Once the input is frozen, the input signal can be removed and the frozen output image is not lost.

Quad-standard video decoding capability — The USP 405 uses a digital, four-line adaptive comb filter to decode NTSC 3.58, NTSC 4.43, PAL, and SECAM signals.

Accu-RATE Frame Lock™ — The patented Extron Accu-RATE Frame Lock™ eliminates artifacts from scaled motion video by eliminating frame rate conversion. It locks the output frame rate to the input frame rate of the active input. The result is a switching system that eliminates image tears and other artifacts from motion video.

Dynamic Motion Interpolation™ (DMI™) — This video processing technique is an advanced motion prediction and compensation method that treats motion content and still content with different algorithms to yield high fidelity images.

3:2 pulldown detection for NTSC and 2:2 film detection for PAL video

sources — These advanced film mode processing features help maximize image detail and sharpness for video sources that originated from film. When film is converted to NTSC video, the film frame rate has to be matched to the video frame rate in a process called 3:2 pulldown. Jaggies and other image artifacts can result if conventional deinterlacing techniques are used on film-source video. The USP 405's advanced film mode processing recognizes signals that originated from film. The USP 405 then applies video processing algorithms that optimize the conversion of video that was made with the 3:2 pulldown process. This results in richly detailed images with sharply defined lines. A similar process is used for PAL film-source video.

Versatile mounting options — The UPS 405 can be rack mounted, or it can be placed on a table or other furniture. Rubber feet and rack mounting hardware are included.

Options and accessories

The USP 405's optional equipment includes:

- **IR 801 remote control** — The Extron IR 801 (part #70-153-01) is an infrared remote control which replicates all of the front panel controls of the USP 405 except the Menu and Next buttons.
- **SDI input card** — Serial digital interface (SDI) input can be added to the USP 405 by the installation of an SDI input card (part #70-168-01).
- **SDI output card** — Serial digital interface (SDI) output can be added to the USP 405 by the installation of an SDI output card (part #70-065-01).



USP 405

Chapter Two

Installation and Operation

Mounting the Scaler

Rear Panel Features

Front Panel Features

Genlock and Vertical Interval Switching

Optimizing the System

Menus, Configuration, and Adjustments

Image Adjustments

Front Panel Security Lockout (Executive mode)

IR 801 Infrared Remote Control

Troubleshooting

Installation and Operation

Mounting the Scaler

Tabletop use

The USP 405 signal processor comes with rack mounting brackets and rubber feet. For tabletop use, attach a self-adhesive rubber foot to each corner of the bottom of the unit.

Rack mounting

For rack mounting, do not install the rubber feet. Attach the provided rack mounting brackets to the USP 405 with machine screws, as shown below, then fasten the USP to the rack using the supplied machine screws.

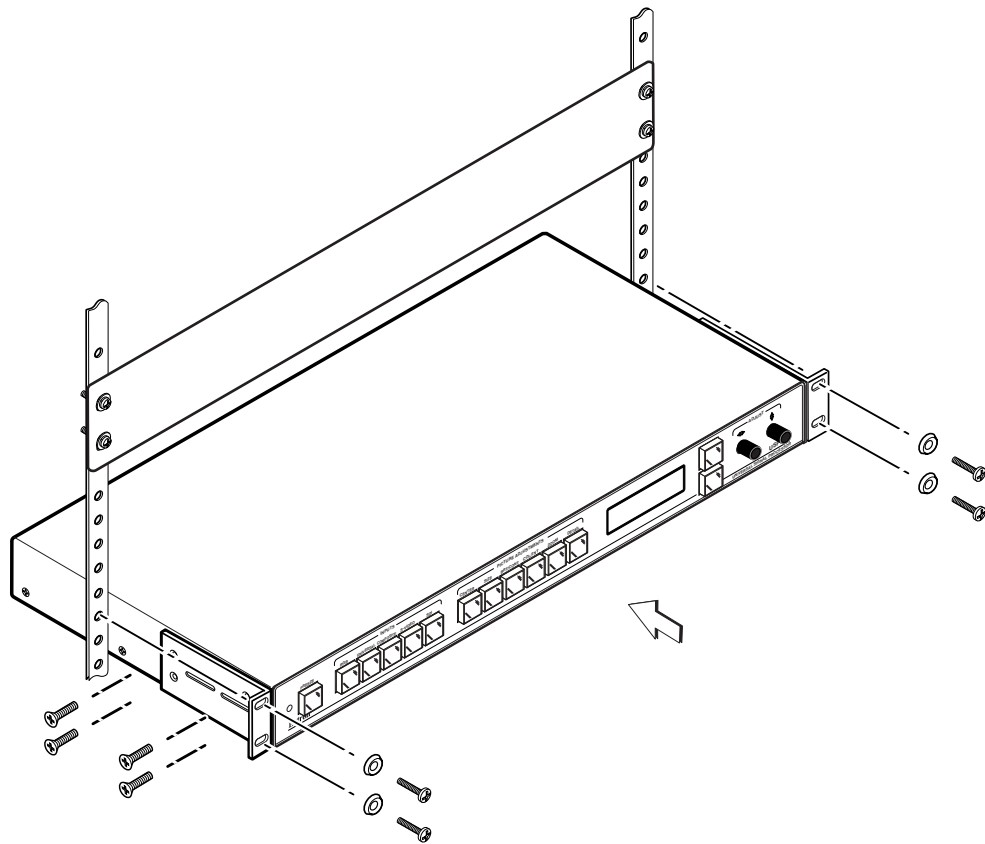

Rack mounting the USP 405

Application diagrams

The diagrams on the next page show examples of typical USP 405 applications and cable connections. The two examples show the USP 405 being used as a scan converter and as a scaler.

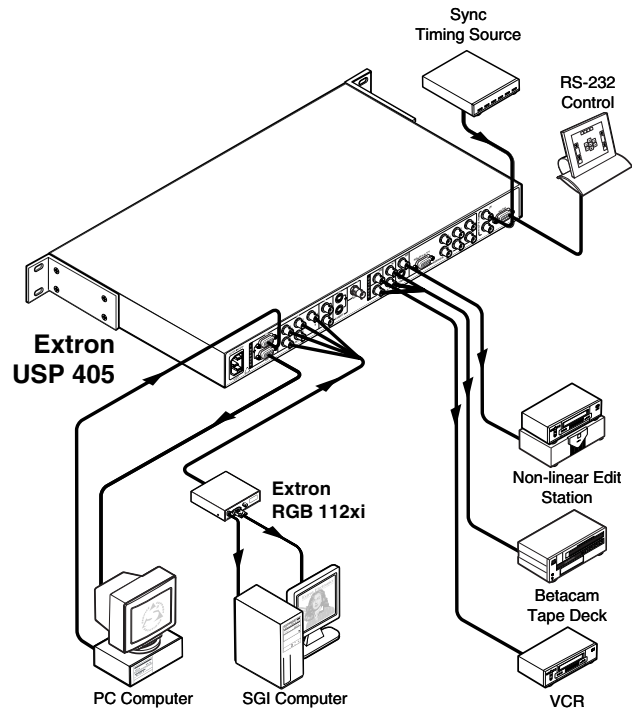

Example of the USP 405 being used as a scan converter

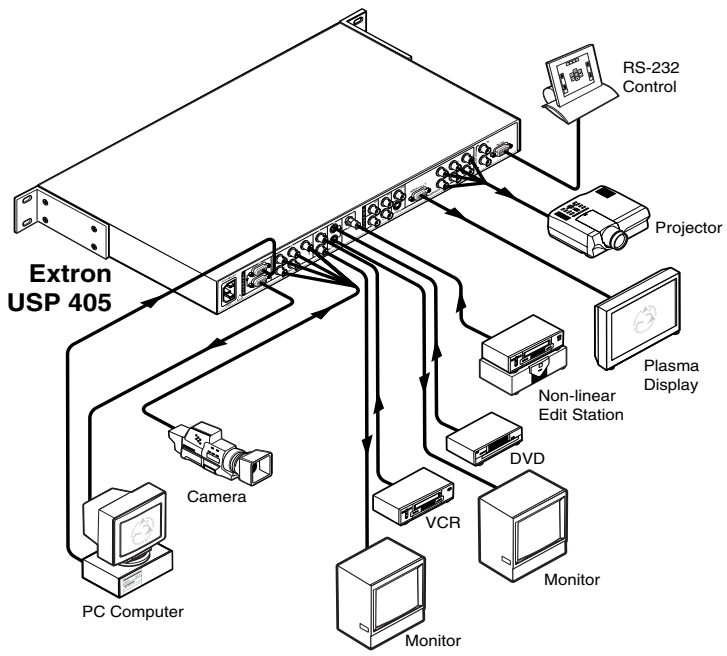

Example of the USP 405 being used as a scaler

Installation and Operation

Rear Panel Features

The rear panel of the USP 405, as shown below, contains all of the possible connectors available on the USP.

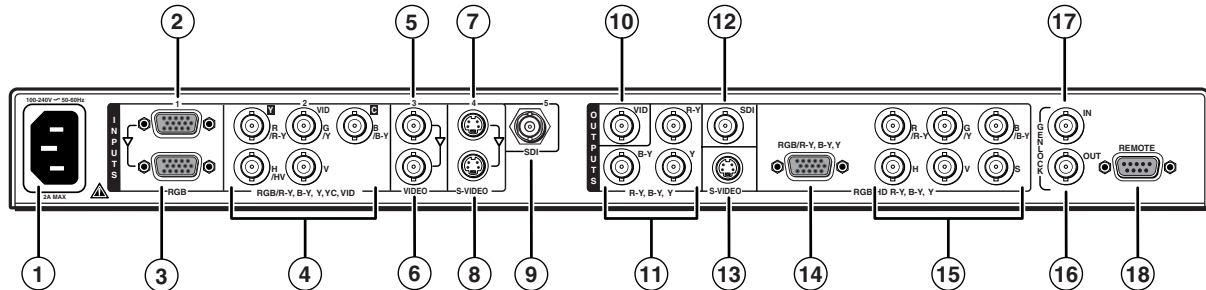

USP 405 rear panel connectors

Power connection

- ① **AC power connector** — Plug a standard IEC power cord into this connector to connect the USP 405 to a 100 to 240VAC, 50 Hz or 60 Hz power source. The front panel control and input selection buttons light in sequence during power-up.

Video input and output connections

- ② ③ **Video input 1** — RGB/computer video is input through the female 15-pin HD connector (②) and the input signal is also buffered and output through a female 15-pin HD connector (③) for loop-through to a local monitor. The RGB input can be scaled to 35 different output resolutions and scan converted for YUV, YC, composite video, or SDI output.

NOTE Output of the SDI signal requires the SDI output card option.

- ④ **Video input 2** — This input, consisting of 5 female BNC connectors, accepts computer video (RGB), component video, composite video, and S-video signals. The input can be scan converted for YUV, YC, composite video, or SDI output. The output can be scaled to 35 different output resolutions. Connect cables for the appropriate signal type, as shown in the following diagram.

NOTE For 24 kHz to 100 kHz RGB signals, Input 2 can accept RGBHV, RGBS, or RGsB formats when “RGB” is the selected input type (see Input Configuration on page 2-13).

For 15 kHz RGB signals (NTSC 3.58/PAL/SECAM/NTSC 4.43), Input 2 can accept RGBS or RGBcvs formats when “RGBcvs” is the selected input type (see Input Configuration on page 2-13).

The USP 405 does not accept any signal between 15.75 kHz and 24 kHz.

NOTE A 15.xx kHz input signal is converted properly only if the input is RGBS or RGBcvs, but a 15.xx kHz RGBHV signal is not successfully converted.

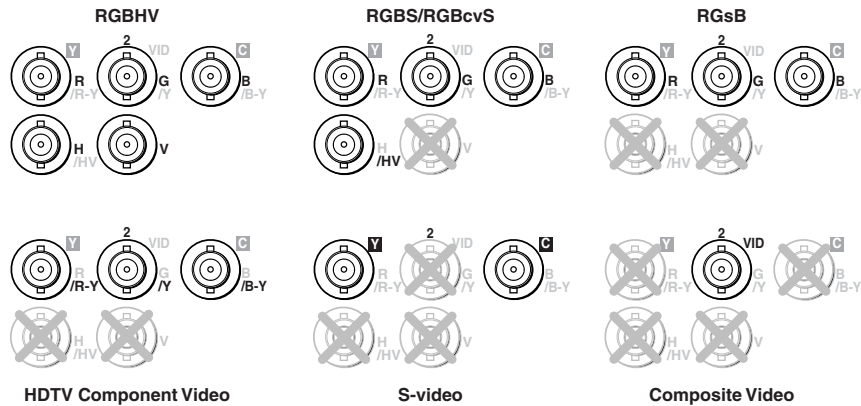

NOTE Output of the SDI signal requires the SDI output card option.

NOTE Equipment following the SCART interconnection standard may be connected to the RGBS input cabling configuration.

- ⑤ ⑥ **Video input 3: Composite video** — A composite video signal is input through the female BNC connector (⑤). A buffered loop-through BNC connector (⑥) outputs the unprocessed composite input signal. The input can be scan converted for YUV, YC, composite video, or SDI output. The output can be scaled to 35 different output resolutions.
- ⑦ ⑧ **Video input 4: S-video** — An S-video signal is input through the female 4-pin mini-DIN connector (⑦). A buffered loop-through mini-DIN connector (⑧) outputs the unprocessed S-video input signal. The input can be scan converted for YUV, YC, composite video, or SDI output. The output can be scaled to 35 different output resolutions.

NOTE Output of the SDI signal requires the SDI output card option.

- ⑨ **Video input 5: SDI (serial digital interface)** — Connect an SDI signal to this female BNC input connector. The input can be scan converted for YUV, YC, composite video, or SDI output. The output can be scaled to 35 different output resolutions.

NOTE Input and output of the SDI signal requires the SDI input card option and the SDI output card option.

- ⑩ **Composite video output** — Using a coaxial cable, connect a composite video display device to this female BNC connector.
- ⑪ **Component video output** — Connect coaxial cables from these 3 female BNC connectors to a component video device for R-Y, B-Y, Y output.
- ⑫ **SDI (serial digital interface) output** — Connect a coaxial cable from this female BNC connector to an SDI output device.

NOTE Output of the SDI signal requires the SDI output card option.

- ⑬ **S-video output** — Connect an S-video output device to this 4-pin mini-DIN connector.

- ⑭ **RGB or component video output** — Connect an RGB or component video (R-Y, B-Y, Y) device to this female 15-pin VGA-style connector.

NOTE Connectors ⑭ and ⑮ output the same signal simultaneously.

Installation and Operation, cont'd

- ⑮ **RGB or HDTV component output** — Connect coaxial cables from these female BNC connectors to an RGB output device or to an HDTV component video device. Connect cables for the appropriate signal type, as shown here.

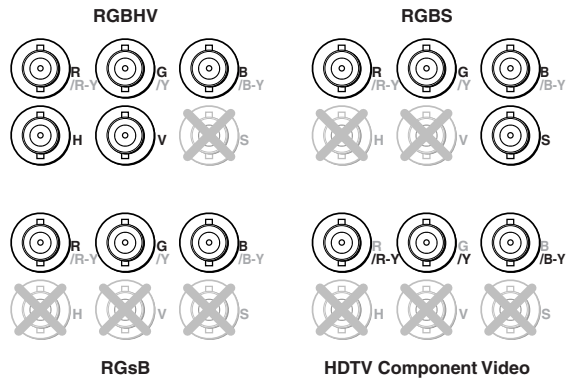

Genlock connections

- ⑯ **Genlock output** — Connect any downstream equipment that requires genlocking to this female BNC connector to route the black burst signal throughout the system in broadcast or other sync-critical applications.
- ⑰ **Genlock input** — Connect an external black burst signal to this female BNC connector for genlocking the video signal in broadcast or other sync-critical applications.

RS-232 connection

- ⑱ **RS-232 port** — This connector provides for two-way RS-232 communication. See the chapter 3, “Serial Communication”, for information on how to install and use the control software and SIS commands.

The default protocol is

- 9600 baud
- 1 stop bit
- no parity
- no flow control.

The rear panel RS-232, 9-pin D connector has the following pin assignments:

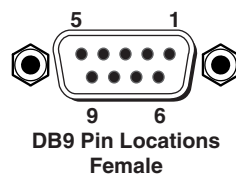

Pin	RS-232 function	Description
1	Input 1	Contact closure
2	Tx	Transmit data
3	Rx	Receive data
4	Input 2	Contact closure
5	Gnd	Signal ground
6	Input 3	Contact closure
7	Input 4	Contact closure
8	Input 5	Contact closure
9	–	No connection

Front Panel Features

The front panel buttons, controls, and LCD of the USP 405, are shown below. The front panel buttons can be labeled using the Button-Label Generator software that is described in chapter 3, “Serial Communication”.

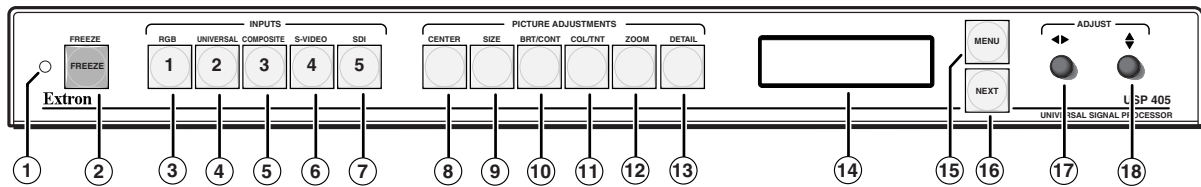

USP 405 front panel

- ① **Infrared sensor** — This sensor is used to receive infrared (IR) signals from the IR 801 remote control. See the “IR 801 Infrared Remote Control” section in this chapter.
- ② **Freeze button** — This button locks the output display to the current image being input. When the freeze function is enabled, this button lights red. To unfreeze the image, press the Freeze button again.

Input selection buttons

The input selection buttons select the video signal type being input. When pressed, these buttons light yellow.

- ③ **RGB input button** — This button selects RGB computer video input from video input 1.
- ④ **Universal input button** — This button selects either RGB video, component video, S-video, or composite video input from video input 2.
- ⑤ **Composite video input button** — This button selects composite video input from video input 3.
- ⑥ **S-video input button** — This button selects the S-video input from video input 4.
- ⑦ **SDI input button (serial digital interface)** — This button selects the SDI input from video input 5.

NOTE *Actual input of the SDI signal requires the SDI input card option.*

Picture adjustment buttons

The picture adjustment buttons select image adjustment controls that are adjusted using the horizontal Adjust (⑰) and vertical Adjust (⑱) adjustment knobs. When pressed, these buttons light green.

- ⑧ **Center control button** — This button selects the centering adjustment for the output display. The horizontal centering adjustment is made using the horizontal Adjust knob and the vertical centering adjustment is made using the vertical Adjust knob. There is no specified adjustment range. See the “Image Adjustments” section in this chapter.
- ⑨ **Size control button** — This button selects the size adjustment for the output display. The horizontal sizing adjustment is made using the horizontal Adjust knob and the vertical sizing adjustment is made using the vertical Adjust knob. There is no specified adjustment range. See the “Image Adjustments” section in this chapter.
- ⑩ **Brightness/Contrast control button (Brt/Cont)** — This button selects the brightness and contrast adjustment for the output display. The adjustment is made using the horizontal Adjust and vertical Adjust adjustment knobs. The adjustment range of brightness is 0 to 63, and contrast is 0 to 255. See the “Image Adjustments” section in this chapter.

Installation and Operation, cont'd

- ⑪ **Color/Tint control button (Col/Tnt)** — This button selects the color and tint adjustment for the output display. The adjustment is made using the horizontal Adjust and vertical Adjust adjustment knobs. The adjustment range of color is 0 to 127, and tint is 0 to 255. See the “Image Adjustments” section in this chapter.

NOTE *The Color/Tint control affects only composite video and S-video.*

- ⑫ **Zoom control button** — This button selects the zoom-in and zoom-out adjustment for the output display. The adjustment is made using the horizontal Adjust and vertical Adjust adjustment knobs. Turning either adjustment knob clockwise will zoom in on the image, and turning either knob counterclockwise will zoom out on the image. See the “Image Adjustments” section in this chapter.
- ⑬ **Detail control button** — This button selects the image detail (sharpness) adjustment for the output display. The adjustment is made using the horizontal Adjust and vertical Adjust knobs. The sharpness adjustment compensates for long cable runs. The horizontal Adjust knob controls the horizontal filter and the vertical Adjust knob controls the vertical filter. The adjustment range of each knob is 0 to 7. See the “Image Adjustments” section in this chapter.

LCD menu display and controls

- ⑭ **LCD** — This screen displays configuration menus and status information. See the “Menus, Configuration, and Adjustments” section in this chapter for details.
- ⑮ **Menu button** — Use this button to enter and move through the main menu system in the USP 405. See the “Menus, Configuration, and Adjustments” section in this chapter for details. This button is always lit yellow.
- ⑯ **Next button** — Use this button to step through the submenus in the USP 405 menu system. See the “Menus, Configuration, and Adjustments” section in this chapter for details. This button is always lit yellow.
- ⑰ **Horizontal Adjust (◀▶) knob** — Rotate this knob to scroll through menu options and make adjustments.
- ⑱ **Vertical Adjust (⬆) knob** — Rotate this knob to scroll through menu options and make adjustments.

Genlock and Vertical Interval Switching

For vertical interval switching (to allow clean switching between signals from several devices during the vertical blanking period of each signal), a composite sync signal can be applied at the Genlock In connector, and can also be passed to another device via the Genlock Out connector.

If the genlock connectors are used only for vertical interval switching, no horizontal or subcarrier phase adjustments are required.

Genlock setup

Genlock differs from simple vertical interval switching in that an external device (a black burst generator) generates a reference sync signal for the system, and every device that uses that signal has its output signal's horizontal and subcarrier phases adjusted to exactly match that of the generator. This allows precise timing and full synchronization. Genlocked systems produce cleaner switches between inputs than do those without this type of synchronization.

An oscilloscope is required for genlock setup, and a vectorscope is recommended. Waveform monitors of types other than a vectorscope may give the appearance that timing is adjusted correctly when it is 180 degrees out of phase. This results in incorrect colors or picture artifacts.

To synchronize the USP 405's video output with a genlock signal, follow these steps:

NOTE *All equipment in the system must be powered up and turned on for at least 15 to 20 minutes before genlock setup adjustments can be made and before the equipment is used in a genlocked application.*

1. Power up and turn on all the devices that will use the genlock signal. The devices must be on for at least 15 to 20 minutes before proceeding with any adjustments.
2. Connect the active timing source signal to the Genlock In connector on the rear panel.
3. Connect the video input signals to the USP 405, as described previously in this chapter.
4. Connect the oscilloscope ("scope") probe A to the Genlock Out connector. This provides the scope's reference signal. In order to avoid altering the genlock signal, use the cabling configuration that will be used in the installation. Either connect the genlock signal cable from the scope to the next device in the system to be timed, or provide 75 ohm termination at the scope's genlock output.

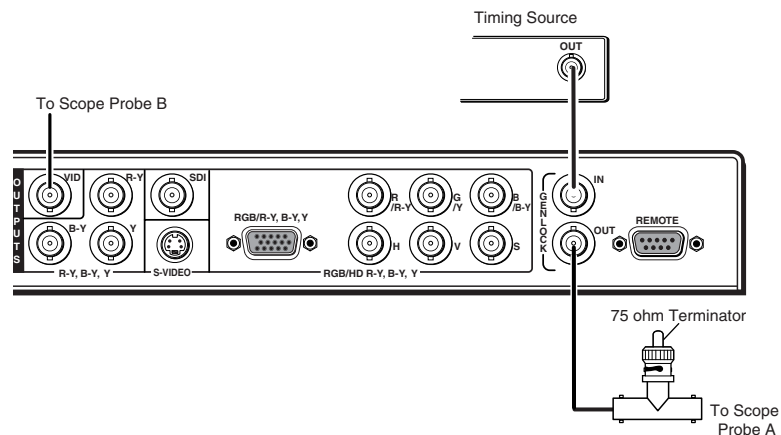

5. Connect scope probe B to the USP 405's composite video output connector.
6. Using the instructions for the scope you are using, set the scope to view the signal's horizontal phases. Adjust the horizontal phase by rotating the horizontal Adjust (◀▶) knob (see the "Genlock Menu" section in this chapter). Adjust the horizontal phase until there is no (0°) difference between the composite video output's horizontal sync phase and the genlock signal's horizontal phase. See the "Oscilloscope displays" section in this chapter.
7. Set the scope to view the subcarrier signals. Adjust the sub phase by rotating the vertical Adjust (⬆⬇) knob until there is a zero phase difference between the genlock signal and the NTSC/PAL output (see the "Genlock menu" section in this chapter).

Installation and Operation, cont'd

8. View the horizontal phases again. If the phase difference is not zero, repeat steps 6 and 7 until the settings do not change.
9. Once the settings are stable, disconnect the oscilloscope, and reconnect the genlock cables.
10. Check the display(s) for proper colors and for undesirable artifacts in the image(s). Make adjustments as necessary.
11. If other USP 405s are part of this genlock daisy chain, connect the oscilloscope to each device, and repeat this procedure.

Oscilloscope displays

What you see on the oscilloscope while adjusting the USP 405 to match the genlock signal depends on the type of signal used, the type of oscilloscope, and the procedure the scope requires. This section shows some examples of oscilloscope displays.

The following diagram shows the genlock input signal (top) and an out-of-alignment NTSC composite sync output signal (bottom) displayed on a waveform monitor to check for alignment. When the phases are aligned, the wave peaks on the bottom waveform should line up with those in the reference signal above it.

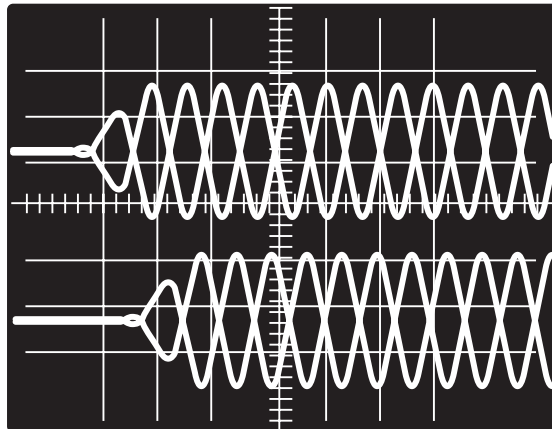

Superimposed waveforms

With this method there is no way to know if the signals are 180° out of phase. A delayed sweep on a time-based scope would allow a more accurate display of the input and output signal phase relationships.

A vectorscope is more accurate than a waveform monitor. The following diagram shows an example of a vectorscope display when the horizontal phase is adjusted to align it with the burst (genlock) vector. Adjust the horizontal phase by rotating the horizontal Adjust (◀▶) knob until the difference between the two vectors is 0°. This example shows black burst only (with no color). The burst vector is pointing to the left from the center.

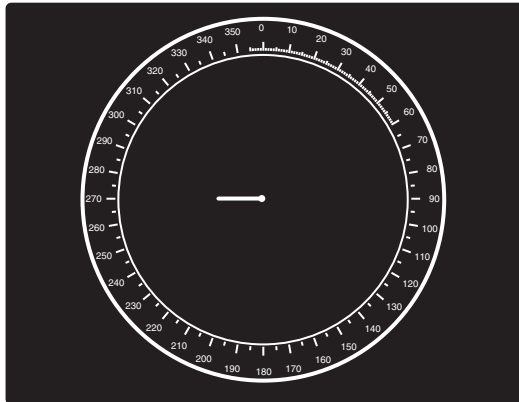

Vectorscope screen during horizontal phase adjustment

The following diagram shows an example of a view of a vectorscope during adjustment of the color subcarrier phase (SC/H). The subcarrier phase should be aligned to 0° (indicated in the figure by the triangle).

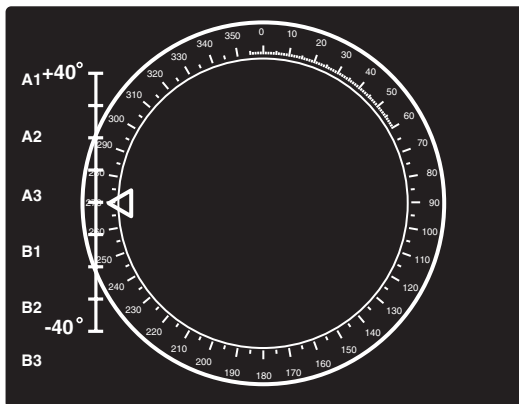

Vectorscope screen during color subcarrier phase adjustment

Optimizing the System

For optimal performance, follow the steps in this section in order when setting up the USP 405 and its input and output devices.

Setting up a DVD source

To get the best results when using a DVD as a video source, Extron recommends that the DVD player itself be set up to output an aspect ratio of 16:9 and not 4:3. Because all DVDs are mastered as 16:9, having them set up for anything else will cause the player to internally scale and compress the signal. This scaling/compression by the DVD player defeats the advantage of having 3-2 pulldown detection in the USP 405.

To change the output aspect ratio of most DVD players,

1. Enter the DVD player's Setup or Action menu while the disc is stopped.
2. Select a 16:9 aspect ratio.

Installation and Operation, cont'd

Menus, Configuration, and Adjustments

USP 405 configuration and adjustments can be performed by using the Windows-based control program (see chapter 3 for details) or by using the front panel controls and the menus that are displayed on the USP's LCD screen. These menus are used primarily when the USP is first set up.

Moving through menus by using front panel controls

Menu button — Press the Menu button to activate menus and to scroll to the five main menus.

Next button — Press the Next button to move between the submenus of a selected main menu. Pressing the Next button during input configuration causes the current input's number and format type to be displayed on the LCD.

Adjust (◀▶, ⬆⬇) knobs — In configuration mode rotate the horizontal Adjust (◀▶) knob and vertical Adjust (⬆⬇) knob to scroll through submenu options and to make adjustment selections. Refer to the flowcharts in this chapter and to specific sections for explanations on knob adjustments.

Image adjustment buttons: Center, Size, Brt/Cont (brightness/contrast), Col/Tnt (color/tint), Zoom, and Detail — When one of these buttons is pressed, the corresponding image adjustment menu appears on the LCD screen. Adjustments can then be made by rotating the horizontal Adjust (◀▶) knob or the vertical Adjust (⬆⬇) knob. Settings and adjustments are stored in nonvolatile memory.

Menu overview

The default screens appear on the LCD when no adjustments are actively being made. When the USP 405 is powered up, the LCD displays a screen showing the USP model (USP 405/USP 405 I/ USP 405 O/ USP 405 IO) for approximately 2 seconds, then the model number and firmware version for approximately 2 seconds, and then the LCD cycles among screens showing the active input's number and video format, the input's horizontal and vertical frequencies, and the output resolution and refresh rate, as shown below.

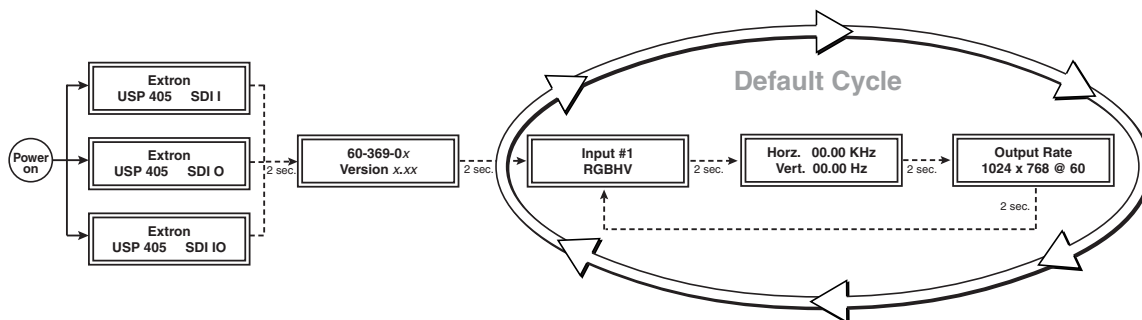

Default menus

NOTE From any menu or submenu, after ten seconds of inactivity the USP 405 saves all adjustment settings and times out to the default screens.

The main menus are shown in the following flowchart. Use the Menu button to scroll between them and the Next button to activate one for viewing or configuration.

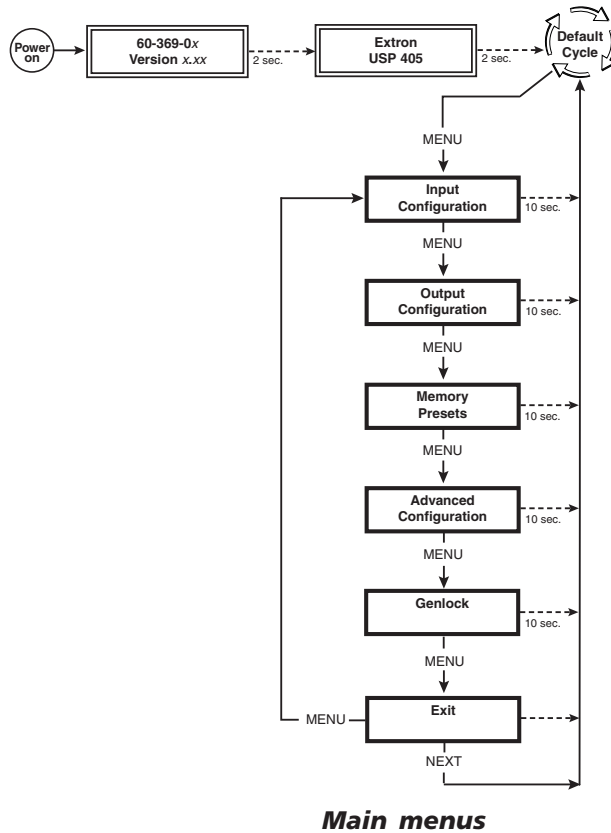

Input Configuration

The following flowchart provides an overview of the Input Configuration submenus and the options for each setting.

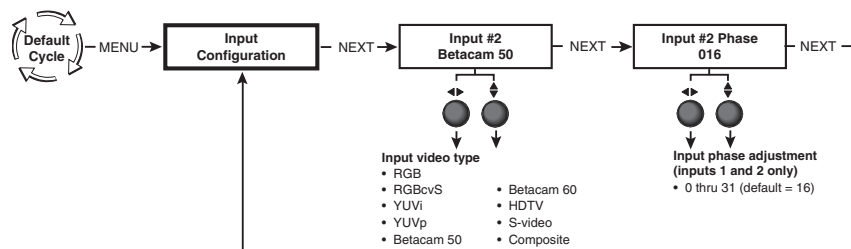

NOTE If you press the Menu button while a submenu is active, the next main menu becomes active. For example, the menu changes from the Input Configuration menu or submenus to the Output Configuration main menu.

NOTE To return to the default screens, let the UPS 405 remain idle for 10 seconds until the selected screen times out, or repeatedly press the Menu button until the Exit Menu appears, then press the Next button.

Installation and Operation, cont'd

Input #2 submenu

Rotate the horizontal Adjust (◄►) knob while in the Input #2 submenu to select the appropriate video format (RGB, RGBcvS, YUVi, YUVp, Betacam 50, Betacam 60, HDTV, S-video, composite video) for input 2. The default for input 2 is Betacam 50.

Input Phase submenu

For RGB (input 1 and 2), HDTV, and YUVp (input 2) input sources, the pixel phase adjustment feature is used to eliminate unwanted noise by setting the sampling rate of the input source. See the following note. Rotate the horizontal Adjust (◄►) or vertical Adjust (⬆) knob to adjust the pixel phase from 0 to 31. The default setting is 16.

NOTE Pixel phase is the timing of the USP 405's sampling rate. Sampling at the optimum pixel phase results in less noise and a brighter scaled output.

Output Configuration

The following flowchart provides an overview of the Output Configuration submenus and the options for each setting.

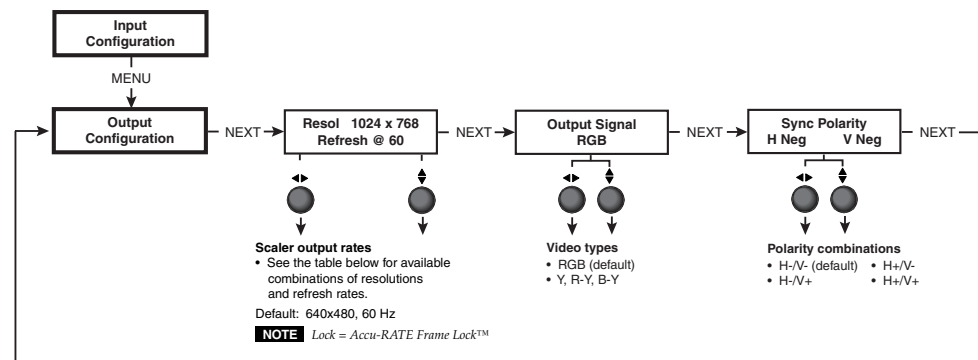

Resolution and refresh rates submenu

The output resolution is defined for each input. Rotate the horizontal Adjust (◄►) knob while in this submenu to select one of the combinations of output resolutions and refresh (vertical scanning) rates.

Rotate the vertical Adjust (⬆) knob while in this submenu to select one of the available refresh rates. Selecting Lock enables the Extron Accu-RATE Frame Lock™ (AFL™) feature. Accu-RATE Frame Lock eliminates image tearing and other artifacts of scaling motion video by eliminating frame rate conversion. It exactly matches the output rate of the USP 405's scaler to the frame rate of the input. Select this feature if you will be using motion video sources with a display that is capable of a variety of refresh rates.

Available Scaler Output Resolutions and Rates						
Resolution	50 Hz	56 Hz	60 Hz	75 Hz	Lock @ 50/60*	85 Hz
640 x 480	X		X	X	X	
800 x 600	X		X	X	X	
832 x 624			X	X	X	
848 x 480			X		X	
852 x 480			X		X	
1024 x 768	X		X	X	X	X
1280 x 768		X			X	
1280 x 1024	X		X		X	
1360 x 765			X		X	
1365 x 1024			X		X	
1400 x 1050	X		X		X	
HDTV 576p	X				X	
HDTV 720p			X		X	
HDTV 1080p			X		X	
HDTV 1080i	X		X		X	
NTSC						
PAL						

* Rate is auto-selected based on input.
The default resolution and rate is 640 x 480 @ 60 Hz.

Output Signal (RGB format) submenu

Using either the horizontal Adjust (◀▶) or vertical Adjust (⬆⬇) knob, select the output format required by the display: RGB (default) or component (Y, R-Y, B-Y).

Sync Polarity submenu

The display or projector may require a particular combination of horizontal (H) and vertical (V) sync signal polarities. Select the appropriate combination of positive or negative H and V sync by rotating either the horizontal Adjust (◀▶) or the vertical Adjust (⬆⬇) knob.

Memory Presets

The following flowchart provides an overview of the Memory Presets submenus and the options for each setting.

NOTE *The presets save only the Sizing and Centering adjustments for the selected output rate. If you change the output and then recall a preset for the earlier rate, the adjustments recalled in the preset have no effect on the video output. However, if you then change back to the earlier output rate, the preset adjustments affect the video output.*

Save memory presets submenu

From this submenu, the sizing and centering information for the currently selected input can be saved to memory. Up to three memory presets can be saved per input: presets 1, 2, and 3.

Installation and Operation, cont'd

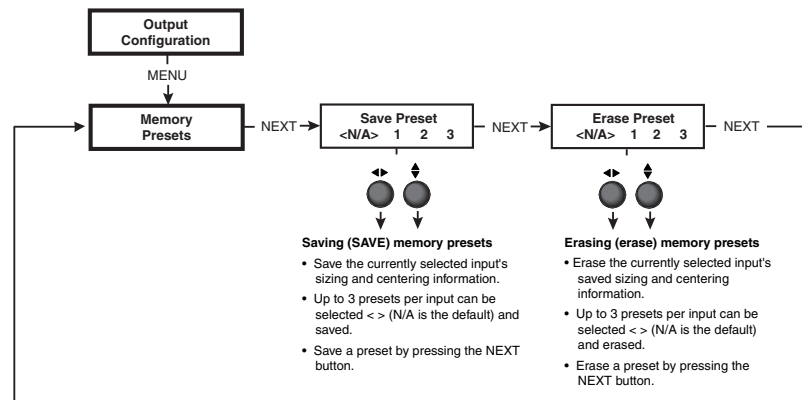

Using either the horizontal Adjust (◀▶) or vertical Adjust (⬆⬇) knob, select (< >) either N/A, 1, 2, or 3 to select a preset. The default is <N/A>. To save the preset, press the Next button.

Erase memory presets submenu

From this submenu, up to three saved presets for the currently selected input can be erased from memory.

Using either the horizontal Adjust (◀▶) or vertical Adjust (⬆⬇) knob, select (< >) either N/A, 1, 2, or 3 to select a preset. The default is <N/A>. To erase the preset, press the Next button.

Recalling a preset

To recalling an input's saved preset, select the input, then press the input button successively to recall any saved preset (up to three saved presets). The available presets are sequentially selected in a loop*: preset 1, preset 2, preset 3, preset 1, preset 2, and so forth, depending on which presets are available.

Each recalled preset displays the LCD message "Input #X Memory Y", where "X" refers to the input (2 to 5) and "Y" refers to the preset (1 to 3). The absence of any saved presets does not display the LCD message for the missing preset.

* The actual presets will depend on what presets (1, 2, or 3) have been saved for an input. For example, if only presets 1 and 3 are available, the sequential looping of the presets as the input button is repeatedly pressed will be: preset 1, preset 3, preset 1, preset 3, and so forth.

NOTE Presets are valid only for the input/output resolutions under which they were saved.

Advanced Configuration

The following flowchart provides an overview of the Advanced Configuration submenus and the options for each setting.

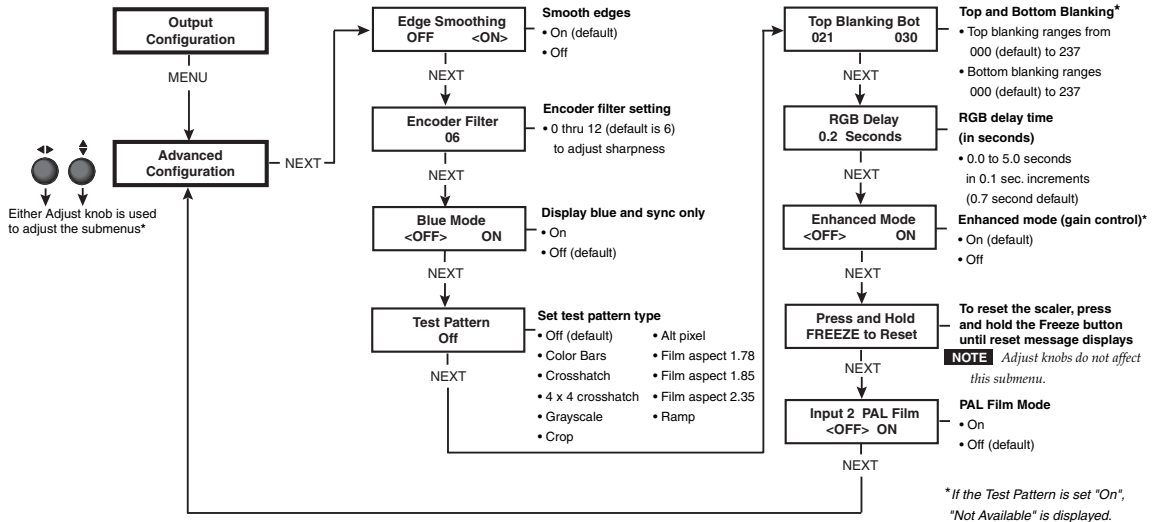

Edge Smoothing submenu

This submenu features edge smoothing. Edge smoothing smooths the edges of a picture by minimizing the differences between pixels.

Using either the horizontal Adjust (◀▶) or vertical Adjust (⬆⬇) knob, select either "On" or "Off". The default is "On".

Encoder Filter submenu

This submenu adjusts the sharpness of the displayed image. The sharpness can be set from 0 to 12 (maximum). The default is 6.

Using either the horizontal Adjust (◀▶) or vertical Adjust (⬆⬇) knob, adjust the filter for the desired sharpness level.

Blue Mode submenu

To aid in setup of the USP 405's color and tint, the Blue Mode can be set from this submenu to "On" so that only sync and blue video signals will be passed to the display. Use either the horizontal Adjust (◀▶) or vertical Adjust (⬆⬇) knob to specify this mode. The default is "Off".

Test Pattern submenu

In this submenu, several test patterns are provided to help adjust the display device for color, convergence, focus, resolution, contrast, grey scale, and aspect ratio. Use either the horizontal Adjust (◀▶) or vertical Adjust (⬆⬇) knob to select a test pattern. The options are: Off, Color Bars, Crosshatch, 4 x 4 Crosshatch, Grayscale, Crop, Alternating Pixel, Film Aspect Ratios 1.78/1.85/2.35, and Ramp. The default is "Off".

NOTE The Alternating Pixel and Ramp test patterns are not available for NTSC or PAL output rates. If one of these patterns is on when the output rate is switched to NTSC or PAL, the test pattern changes to color bars.

Installation and Operation, cont'd

Top and Bottom Blanking submenu

To remove noise or extraneous material such as closed captioning, remove scan lines at either the top or bottom of the screen by adjusting the top blanking or bottom blanking. Rotate the horizontal Adjust (◄►) knob to adjust the top blanking from 0 to 237 lines. The default is 0. Rotate the vertical Adjust (⬆) knob to adjust the bottom blanking from 0 to 237 lines. The default is 0.

RGB Delay (Triple-Action Switching™) submenu

With Triple-Action Switching, the USP 405 switches to the new sync signal before switching RGB (video) signals. That allows the display device to adjust to the new sync timing during a brief delay before displaying the new picture, which will appear without glitches. Triple-Action Switching is also known as video mute switching. When the USP 405 is outputting a low resolution video signal (PAL /NTSC), the RGB delay setting also adjusts the interval that the video is muted.

Use the horizontal Adjust (◄►) knob or vertical Adjust (⬆) knob to select the blanking period (RGB delay time) from 0 seconds to 5 seconds in 0.1 second steps. The default is 0.7 seconds.

Enhanced mode submenu

When the Enhanced mode is set "On", automatic gain control of the video input signal is enabled. If the input signal is too weak, the signal gain will be increased, and if the input signal level is excessive, the signal gain will be decreased.

NOTE *Enhanced mode is effective only for S-video and composite video input.*

From this submenu, use either the horizontal Adjust (◄►) knob or vertical Adjust (⬆) knob to specify this mode as "On" or "Off". The default is "Off".

PAL Film mode detect (2:2 pulldown detection) submenu

For the currently selected input, set this feature to "On" if the source is PAL video that originated in film. For standard PAL video sources, such as cameras, set this feature to "Off" (default).

NOTE *This setting is available only for inputs 2 – 5.*

NOTE *This feature does not apply to NTSC video sources since film mode (3:2 pulldown) is automatically detected for those signals.*

From this submenu, use either the horizontal Adjust (◄►) knob or vertical Adjust (⬆) knob to specify this mode as "On" or "Off".

Reset submenu

The USP 405 can be reset to the default values by depressing the Freeze button while this submenu is active. Release the button after receiving the "Unit Reset to Factory Defaults" message (about 2 seconds).

Genlock menu

The following flowchart provides an overview of the Genlock menu and the options for each submenu setting.

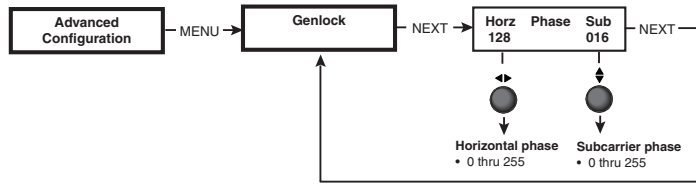

Exit menu

From this menu, press the Next button to return to the Default menu cycle, or press the Menu button to return to the Input Configuration menu.

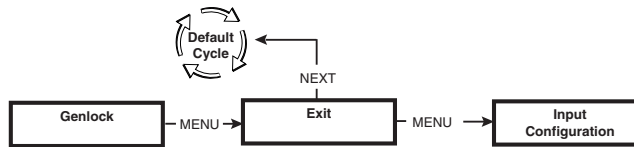

Image Adjustments

Picture adjustments apply to scaled video output only; RGB signals are passed through without adjustments.

Color, tint, brightness, contrast, detail, sizing, zoom, centering

To adjust an image for centering, sizing, brightness, contrast, color, tint, zoom, or detail, follow the steps below. The illustration below shows the process of making of color adjustments to the image. The other picture adjustments follow a similar procedure.

1. Press the input selection button of the input you wish to adjust.
2. Press the appropriate picture adjustment button for centering (Center), sizing (Size), brightness/contrast (Brnt/Cont), color/tint (Col/Tnt), zoom, or detail. The LCD display shows the name of the adjustment and the value of the current setting.
3. Rotate the horizontal Adjust knob (◀▶) or vertical Adjust knob (⬆⬇) to select a level from the following adjustment ranges:

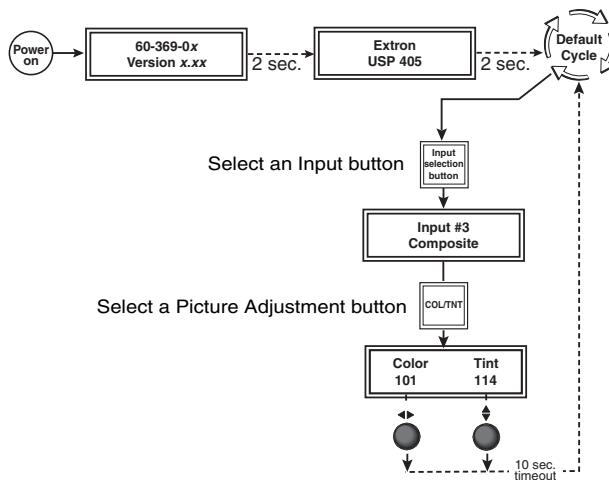

NOTE With an input signal present, the following picture adjustment(s) are "Not Available" for the respective inputs with exceptions in ():

Input 1: color and tint (not available anytime)

Input 2: tint (but available only if S-video or composite is selected and NTSC signal is input)

Input 3: tint (but available only if an NTSC signal is input)

Input 4: tint (but available only if an NTSC signal is input)

Input 5: color, tint, and detail

NOTE If the Test Pattern submenu in the Advanced Configuration menu has been set to any pattern other than "Off", "Crop", or a "Film aspect" crop pattern, the picture control adjustments will be disabled ("Not Available").

NOTE The horizontal Adjust knob and the vertical Adjust knob are used to adjust the image settings on the left and right sides of the LCD screen, respectively.

Installation and Operation, cont'd

NOTE The Adjust knobs have no mechanical limits to their rotation.

- Centering: Horizontal (Horz) adjusts horizontal positioning.
Vertical (Vert) adjusts vertical positioning.
- Sizing: Horizontal (Horz) adjusts horizontal sizing.
Vertical (Vert) adjusts vertical sizing.
- Brightness/Contrast: Brightness adjusts from 0 to 63.
Contrast adjusts from 0 to 255.
- Color/Tint: Color adjusts from 0 to 127.
Tint adjusts from 0 to 255.
- Zoom: Adjust zoom by observing the display and turning either adjustment knob either clockwise (zoom in) or counterclockwise (zoom out). The image increases/decreases in size both horizontally and vertically.
- Detail: Detail adjusts image sharpness from 0 to 7.

The USP 405 times out to the default menu after 10 seconds.

4. Repeat steps 2 and 3 for each image adjustment to be made for that input.

NOTE The LCD display may show that an adjustment is "Not Available" in place of a number if that adjustment does not apply to the input's video format. The following input types display "Not Available" during certain picture adjustments; all other input types have full picture adjustments:

Input 1 RGB: no color and no tint, anytime

Input 2 RGB, RGBcvS: no color or tint anytime; YUVi, YUVp, Betacam 50, Betacam 60, composite (PAL), S-video (PAL) and HDTV: no tint (but there is color)

Input 3 composite (PAL): no tint (but there is color)

Input 4 S-video (PAL): no tint (but there is color)

Input 5 (SDI): no color, no tint, no detail

Front Panel Security Lockout (Executive mode)

To prevent accidental changes to settings, press the Size and Zoom buttons simultaneously for 2 seconds to enable the USP 405's front panel security lockout (Executive mode). Executive mode locks all front panel functions except input selection and the Freeze button. The menu system still returns to the default cycle when 10 seconds have elapsed. The USP 405's front panel and the IR 801 are both affected by Executive mode. When Executive mode is active, all functions and adjustments can still be made through RS-232 control. For details on RS-232 control, see chapter 3.

To disable the Executive mode, press the Size and Zoom buttons simultaneously for 2 seconds.

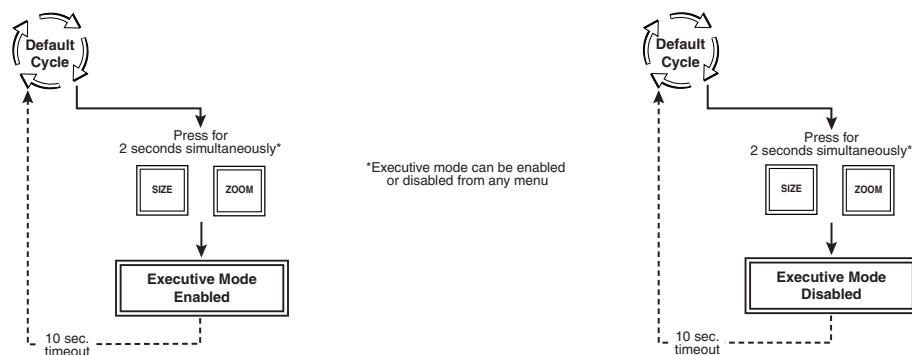

IR 801 Infrared Remote Control

The optional IR 801, shown at right, replicates all of the front panel controls except the Menu and Next buttons. If Executive mode is enabled, selections and adjustments can still be made using the IR 801, but you must use the USP 405's front panel or the Windows-based control program (via an RS-232 device) to configure and program the USP. See chapter 3, "Serial Communication", for details.

NOTE While Executive mode is active, adjustments can still be made using the IR 801.

The topmost part of the IR 801 features three aspect ratio preset buttons, a horizontal filters button, a freeze button, and a vertical filters button.

NOTE The horizontal and vertical filtering apply only to the following input formats:

Input 1: RGB

Input 2: RGB, YUVp, HDTV

The middle portion of the IR 801 features five input selection buttons, the size buttons for sizing an image, and the shift buttons for centering an image.

The bottom portion of the IR 801 contains the adjustment controls for color, tint, brightness, contrast, detail, and zoom adjustments.

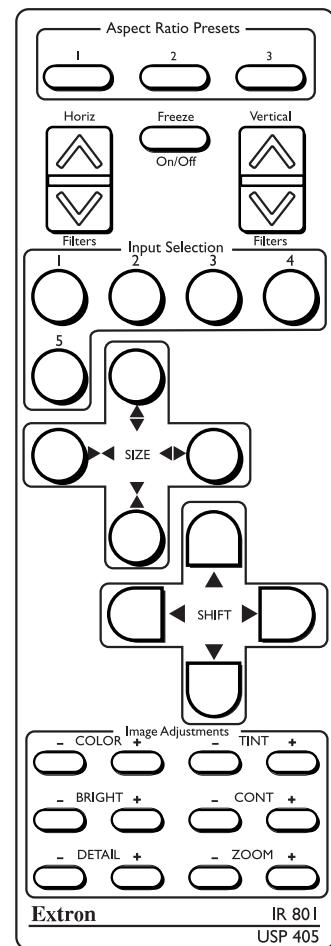

Selecting an input

To use the IR 801 to select an input, press the button corresponding to the input number.

Freezing an input

To freeze the input being displayed, press the Freeze On/Off button. To unfreeze the input, press the Freeze button again.

Aspect ratio presets

Up to three saved memory presets may be recalled by pressing one of the three Aspect ratio preset buttons. Sizing and centering information are saved with the presets.





Installation and Operation, cont'd

Horizontal and vertical filtering

- The horizontal filter adjustment button will enhance image detail. Pressing the up arrow button will increase the horizontal filtering, and pressing the down arrow button will decrease the horizontal filtering. The range of adjustment is 0 through 7.
- The vertical filter adjustment button will reduce image flicker while maintaining image sharpness. Pressing the up arrow button will increase the vertical filtering, and pressing the down arrow button will decrease the vertical filtering. The range of adjustment is 0 through 7.

NOTE For composite, YUVi, S-video, and RGBcV input formats, the **Detail** image adjustments (+ and -) are used instead of the horizontal and vertical filters.

Adjusting image size

To adjust image size, press the  button to increase vertical size, the  button to decrease the vertical size, the  button to increase horizontal size, or the  button to decrease horizontal size.

Shifting the image





Press the  button to shift the image to the left, the  button to shift the image to the right, the  button to shift the image up, or the  button to shift the image down.

Image adjustments

The + and – picture adjustment controls (**Color**, **Tint**, **Brightness**, **Contrast**, **Detail**, and **Zoom**) increment or decrement the picture adjustment settings.

Troubleshooting

This section gives recommendations on what to do if you have problems operating the USP 405, and it provides examples and descriptions for some image problems you might encounter.

The following are some tips to help you in troubleshooting:

- Some symptoms may resemble others, so you may want to look through all of the examples before attempting to solve the problem.
- Be prepared to backtrack in case the action taken doesn't solve the problem.
- It may help to keep notes and sketches in case the troubleshooting process gets lengthy. This will also give you something to discuss if you call for technical support.
- Try simplifying the system by eliminating components that may have introduced the problem or made it more complicated.
- **For sync-related problems:** Portable digital projectors are designed to operate close to the video source. Sync problems may result from using long cables or from improper termination. A sync adapter, such as Extron's ASTA (active sync termination adapter), may help solve these problems.
- **For LCD and DLP projectors and plasma displays:** In addition to the sync-related information above, check the user's manual that came with the projector for troubleshooting tips, as well as for settings and adjustments. Each manufacturer may have its own terms, so look for terms like "auto setup", "auto sync", "pixel phase", and "tracking".

Operating problems

The table below shows some common operating problems and their solutions.

Problem	Cause	Solution
No image appears.	The input signal is incompatible.	Make sure that the input signal is the appropriate type and frequency for the given input.
	Freeze mode was entered when the image was black.	Deactivate freeze mode.
The image is frozen.	The scaled output rate is too high for the display.	Change the scaled output to a compatible resolution.
	Freeze mode is on.	Deactivate freeze mode. If that does not work, unplug the power cord from the unit, then plug it back in.
The image is flashing.	The scaled output rate is too high for the display.	Change the scaled output to a compatible resolution.
The image is green.	The output sync is configured for sync on green.	Turn off sync on green.
	The RGB/Y, R-Y, B-Y output is set for Y, R-Y, B-Y.	Set the output signal for RGB.
The image is too soft.	The detail/sharpness level needs to be changed.	Change the detail/sharpness.
No color/tint picture adjustment.	Color/tint affects only composite video and S-video.	Verify the video format.
The USP randomly switches to an input.	An RS-232 cable, with all pins being passed, is connecting the USP to a PC.	Verify that the RS-232 cable is only passing pins 2, 3, and 5.
The image glitches when a VCR source is used and the USP is set to the "Lock" refresh rate.	The sync of the VCR's output may be too unstable for Accu-RATE Frame Lock (AFL).	Set the refresh rate to another rate.
Various adjustments read "Not Available".	One of the test patterns (other than crop or a film aspect crop) has been enabled.	From the "Test Pattern" submenu of the Advanced Configuration menu, set the test pattern to "off" or to a crop pattern.

Installation and Operation, cont'd



USP 405

3

Chapter Three

Serial Communication

RS-232 Programmer's Guide

Control Software for Windows

Labeling Buttons on the USP 405

Setting the Output Rate Using the Per Input Feature

Serial Communication

The USP 405 can be remotely controlled via a host computer or other device (such as a control system) attached to the rear panel RS-232 connector. The control device (host) can use either Extron's Simple Instruction Set (SIS) commands or the graphical control program for Windows.

The signal processor uses a protocol of 9600 baud, 1 stop bit, no parity, and no flow control.

The rear panel RS-232, 9-pin D connector has the following pin assignments:

Pin	RS-232 function	Description
1	Input 1	Contact closure
2	Tx	Transmit data
3	Rx	Receive data
4	Input 2	Contact closure
5	Gnd	Signal ground
6	Input 3	Contact closure
7	Input 4	Contact closure
8	Input 5	Contact closure
9	-	No connection

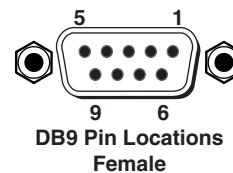

RS-232 Programmer's Guide

Host-to-signal processor communications

SIS commands consist of one or more characters per field. No special characters are required to begin or end a command sequence. When the USP 405 determines that a command is valid, it executes the command and sends a response to the host device. All responses from the signal processor to the host end with a carriage return and a line feed (CR/LF = ↵), which signals the end of the response character string. A string is one or more characters.

It is also possible to send several SIS commands back-to-back in sequence.

Signal processor-initiated messages

When a local event such as a front panel selection or adjustment takes place, the USP 405 signal processor responds by sending a message to the host. No response is required from the host. The signal processor-initiated messages are listed here (underlined).

(C) Copyright 2002, Extron Electronics, USP 405, Vx.xx ↵

The USP 405 sends the copyright message when it first powers on. Vx.xx is the firmware version number.

Chn[x] ↵ (where [x] is the input number)

The USP 405 sends this response when an input is switched.

Error responses

When the USP 405 receives a valid SIS command, it executes the command and sends a response to the host device. If the USP is unable to execute the command because the command is invalid or it contains invalid parameters, it returns an error response to the host.

The error response codes and their descriptions are as follows:

E01 – Invalid input channel number (the number is too large)

E10 – Invalid command

E11 – Invalid preset value

E13 – Invalid value (the number is out of range/too large)

E17 – Illegal command for this signal type

Using the command/response tables

The command/response tables starting on the next page list valid command ASCII codes, the USP 405's responses to the host, and a description of the command's function or the results of executing the command. Uppercase and lowercase characters may be used interchangeably in the command field.

ASCII to HEX Conversion Table												Esc 1B	CR 0D	LF 0A			
20	!	21	"	22	#	23	\$	24	%	25	&	26	'	27			
(28)	29	*	2A	+	2B	,	2C	-	2D	.	2E	/	2F		
0	30	1	31	2	32	3	33	4	34	5	35	6	36	7	37		
8	38	9	39	:	3A	;	3B	<	3C	=	3D	>	3E	?	3F		
@	40	A	41	B	42	C	43	D	44	E	45	F	46	G	47		
H	48	I	49	J	4A	K	4B	L	4C	M	4D	N	4E	O	4F		
P	50	Q	51	R	52	S	53	T	54	U	55	V	56	W	57		
X	58	Y	59	Z	5A	[5B	\	5C]	5D	^	5E	_	5F		
`	60	a	61	b	62	c	63	d	64	e	65	f	66	g	67		
h	68	i	69	j	6A	k	6B	l	6C	m	6D	n	6E	o	6F		
p	70	q	71	r	72	s	73	t	74	u	75	v	76	w	77		
x	78	y	79	z	7A	{	7B		7C	}	7D	~	7E	DEL	7F		

The ASCII to HEX conversion table at left is for use with the command/response tables.

ASCII to Hex conversion table

The command/response tables use symbols (defined below) to represent variables.

Symbol definitions

- ↵ = CR/LF (carriage return/line feed) (hex 0D 0A)
- ← = CR (carriage return) (hex 0D)
- = Space
- Esc** = Escape key
- X1** = Specific input number (1 thru 5)
- X2** = Brightness value (0 thru 63)
- X3** = Color value (0 thru 127)
- X4** = Tint and contrast value (0 thru 255)
- X5** = Specific input number (0 thru 5) where 0 refers to all inputs
- X7** = Scaler resolution:

0 = 640x480	9 = 1365x1024
1 = 800x600	10 = 1400x1050
2 = 832x624	11 = 576p
3 = 848x480	12 = 720p
4 = 852x480	13 = 1080p
5 = 1024x768	14 = 1080i
6 = 1280x768	15 = NTSC
7 = 1280x1024	16 = PAL
8 = 1360x765	17 = custom/per input
- X8** = Video type:

0 = RGB	5 = Betacam 50
1 = RGBcvS	6 = HDTV
2 = YUVi	7 = S-video
3 = YUVp	8 = Composite
4 = Betacam 50	
- X9** = 0 = off, 1 = on
- X10** = Horizontal/vertical filter setting (0 through 7)
- X12** = Test pattern type (0 through 10)

0 = off	9 = ramp
1 = color bars	10 = alternating pixels
2 = crosshatch	
3 = 4x4 crosshatch	
4 = grey	
5 = crop	
6 = film aspect ratio 1.78	
7 = film aspect ratio 1.85	
8 = film aspect ratio 2.35	
- X15** = xxx.xx where

Hrt = horizontal rate (kHz)
Vrt = vertical rate (Hz)

 xxx:xx means signal out of range
- X16** = Detected input signal standard (0 through 4)

0 = none
1 = NTSC 3.58
2 = PAL
3 = NTSC 4.43
4 = SECAM
- = not applicable (occurs when the input is set for RGB, YUV, or progressive YUV)
- X18** = Blanking adjustment range (0 through 237)
- X19** = Input configuration preset (1 through 3)
- X20** = Scaler refresh rate

0 = 50 Hz
1 = 56 Hz (1280x768 only)
2 = 60 Hz
3 = 75 Hz
4 = 85 Hz (1024x768 only)
5 = AFL* (50 Hz for PAL or 59.94 Hz for NTSC)
6 = NTSC or PAL refresh (must be used with these scaler resolutions)
7 = not applicable
- *NOTE: Lock or AFL is Accu-RATE Frame Lock™
- X21** = Phase adjustment setting (0 through 31)

Serial Communication, cont'd

Command/response table for SIS commands

Command	ASCII Command (host to USP)	Response (USP to host)	Additional description
Input selection			
Select video	[X1] !	In• [X1]All ↵	Video input [X1].
<i>Example:</i>	2!	In 02All ↵	Select input 2 video.
Select video only	[X1] &	In• [X1]Vid ↵	Video input [X1].
Input 2 video type			
Set video type, input 2 only	[X8] \	Typ [X8]↵	Specify input 2 video type.
<i>Example:</i>	3\	Typ 3↵	Specify input 2 type as YUVp.
View video type	\	[X8]↵	Input 2 video type is [X8].
Memory preset			
Recall input configuration preset	[X19].	Rpr [X19] ↵	Recall input preset [X19].
Save input configuration preset	[X19],	Spr [X19] ↵	Save to input preset [X19].
Color			
Set a specific color value	[X3] C	Col [X3] ↵	Specify a color adjustment level.
<i>Example:</i>	47C	Col047↵	Set the color adjustment to 47.
Increment	+C	Col [X3] ↵	Increase color adjustment level.
Decrement	-C	Col [X3] ↵	Decrease color adjustment level.
View the color value	C	[X3] ↵	Show the color adjustment.
Tint			
Set a specific tint value	[X4] T	Tin [X4] ↵	Specify a tint adjustment level.
<i>Example:</i>	176T	Tin176↵	Set the tint to 176.
Increment	+T	Tin [X4] ↵	Increase tint adjustment level.
Decrement	-T	Tin [X4] ↵	Decrease tint adjustment level.
View the tint value	T	[X4] ↵	Show the tint adjustment.
Contrast			
Set a specific contrast value	[X4] ^	Con [X4] ↵	Specify the contrast adjustment.
Increment	+^	Con [X4] ↵	Increase the contrast.
Decrement	-^	Con [X4] ↵	Decrease the contrast.
View the contrast value	^	[X4] ↵	Show the contrast setting.
Brightness			
Set a specific value	[X2] Y	Brn [X2] ↵	Specify the brightness adjustment.
Increment	+Y	Brn [X2] ↵	Increase the brightness.
Decrement	-Y	Brn [X2] ↵	Decrease the brightness.
View the brightness value	Y	[X2] ↵	Show the brightness setting.
Zoom mode			
Zoom in	+{	Zom ↵	Zoom in.
Zoom out	-{	Zom ↵	Zoom out.
Horizontal centering			
Increment	+H	Hph ↵	Shift right.
Decrement	-H	Hph ↵	Shift left.
Vertical centering			
Increment up	+/	Vph ↵	Shift up.
Increment down	-/	Vph ↵	Shift down.

Command/response table for SIS commands (continued)

Command	ASCII Command (host to USP)	Response (USP to host)	Additional description
Horizontal size			
Increase the horizontal size	+:	Hsz ↵	Widen the picture.
Decrease the horizontal size	-:	Hsz ↵	Make the picture narrower.
Vertical size			
Increase the vertical size	+;	Vsz ↵	Make the picture taller.
Decrease the vertical size	-;	Vsz ↵	Make the picture shorter.
Horizontal detail filter – RGB & HDTV only			
Set a specific filter value	[X10] D	Dhz [X10] ↵	Set the horizontal detail level.
Increment	+D	Dhz [X10] ↵	Increase the horizontal detail.
Decrement	-D	Dhz [X10] ↵	Decrease the horizontal detail.
View the horizontal filter value	D	[X10] ↵	Show the horizontal detail level.
Vertical detail filter – RGB & HDTV only			
Set a specific filter value	[X10] d	Dvz [X11] ↵	Set the vertical detail level.
Increment	+d	Dvz [X11] ↵	Increase the vertical detail.
Decrement	-d	Dvz [X11] ↵	Decrease the vertical detail.
View the vertical filter value	d	[X11] ↵	Show the vertical detail level.
Detail filter – all other formats except RGB & HDTV			
Set a specific detail filter value	[X10] D	Dhz [X10] ↵	Set the detail level.
Increment	+D	Dhz [X10] ↵	Increase the detail.
Decrement	-D	Dhz [X10] ↵	Decrease the detail.
View the detail filter value	D	[X10] ↵	Show the detail level.
Top blanking			
Specify a top blanking value	[X18] (Blt [X18] ↵	Set the number of lines to blank at the top of the picture.
Increase the top blanking value	+(Blt [X18] ↵	Increase the # of top lines blanked.
Decrease the top blanking value	-(Blt [X18] ↵	Decrease the # of top lines blanked.
View the top blanking value	([X18] ↵	Show the number of lines that are blanked at the top of the picture.
Bottom blanking			
Specify a bottom blanking value	[X18])	Blb [X18] ↵	Set the number of lines to blank at the bottom of the picture.
Increase the bottom blanking value	+))	Blb [X18] ↵	Increase the number of lines blanked at the bottom.
Decrease the bottom blanking value	-))	Blb [X18] ↵	Decrease the number of bottom lines blanked.
View the bottom blanking value)	[X18] ↵	Show the # of bottom lines that are blanked.
Freeze			
Enable	1F	Frz1 ↵	Output a “frozen” video image.
Disable	0F	Frz0 ↵	Turn off freeze (output motion video).

(Continued)

Serial Communication, cont'd

Command/response table for SIS commands (continued)

Command	ASCII Command (host to USP)	Response (USP to host)	Additional description
View the freeze status <i>Example:</i>	F F	X9 ↵ 0 ↵	Show the freeze status.
Pixel phase			
Set a specific pixel sampling phase <i>Example:</i>	X1 * X21 U 1*17U	X1 Phs X21 ↵ 1Phs17 ↵	Specify the pixel sampling phase. Set the sample phase to 17 for input 1.
Increment sampling value	X1 + U	X1 Phs X21 ↵	Increase the phase value.
Decrement sampling value	X1 - U	X1 Phs X21 ↵	Decrease the phase value.
View the sampling value	X1 U	X21 ↵	Show the pixel sampling phase.
Front panel security lockout (executive mode)			
Disable	0X	Exe0 ↵	Adjustments & selections can be made from the front panel.
Enable (lock image adjustments)	1X	Exe1 ↵	Lock front panel adjustments; adjust image via RS-232 only.
View the executive mode status <i>Example:</i>	X X	X9 ↵ 0 ↵	Show executive mode status. Executive mode off.
Test pattern			
Select test pattern	X12 J	Tst X12 ↵	Select a test pattern.
Select test pattern	X12 j	Tst X12 ↵	Select a test pattern.
View test pattern <i>Example:</i>	J/j J	X12 ↵ 0 ↵	Show the test pattern. Test pattern off.
Scaler output rate			
Set the output rate	X7 * X20 =	Rte X7 * X20 ↵	Select a global scaler output scan rate.
View the output rate	=	X7 * X20 ↵	Show the global scaler output rate.
Set the output rate per input	X7 * X20 * X5 =	Rte X7 * X20 ↵	Select a scaler output scan rate for input X5. An input of 0 sets a global output rate for all inputs.
View the output rate per input	X5 =	X7 * X20 ↵	Show the scaler output rate. When input X5 = 0, the global output rate (prior to setting the rate using the per input command) is displayed.
Firmware version, part number & information requests			
Query firmware version number	Q/q	x.xx ↵	Show the controller firmware version.
Request part number	N/n	xx-xxx-xx ↵	Show the USP 405's part #.
Request general info.	I/i	(See below) Vid X1 • Hrt X15 • Vrt X15 • Std X16 • Pre X19 ↵	Show the USP 405's status.
Zap (reset to default settings)			
Zap all USP 405 settings	Esc zXXX←	ZpX ↵	Reset everything: all settings, and adjustments to the factory default.

The syntax for setting a special function is $\boxed{x?} * \boxed{x!} \#$ where $\boxed{x?}$ is the function number and $\boxed{x!}$ is the value. To view a function's setting, use $\boxed{x?}\#$ where $\boxed{x?}$ is the function number. In the following table the values of the $\boxed{x?}$ variable are different for each command/function. These values are given in the far right column.

Command/response table for special function SIS commands

Command	ASCII Command (host to USP)	Response (USP to host)	$\boxed{x!}$ values and additional descriptions
Delay times			
RGB delay (Triple-Action Switching)	$3 * \boxed{x!} \#$	Dly $\boxed{x!} \leftarrow$	0 = 0.0 seconds (default), 1 = 0.1 seconds, 2 = 0.2 seconds, ... in 0.01 second steps up to 50 = 5.0 seconds.
<i>Example:</i>	3*35#	Dly35 \leftarrow	RGB delay set to 3.5 seconds.
Encoder filter.			
Switching effect	$10 * \boxed{x!} \#$	Enc $\boxed{x!} \leftarrow$	Encoder values 0 through 12.
<i>Example:</i>	10*3#	Enc03 \leftarrow	Encoder set to 3.
Scaler settings			
Output signal	$6 * \boxed{x!} \#$	Tpo $\boxed{x!} \leftarrow$	0 = RGB (default). 1 = R-Y, Y, B-Y.
<i>Example:</i>	6*1#	Tpo1 \leftarrow	RGB output signal
Output polarity	$7 * \boxed{x!} \#$	Pol $\boxed{x!} \leftarrow$	0 = H-/V- (default). 1 = H-/V+. 2 = H+/V-. 3 = H+/V+.
<i>Example:</i>	7*1#	Pol1 \leftarrow	<i>Example:</i> H-/V+ output polarity
Blue screen			
Blue screen (blue & sync output only)	$8 * \boxed{x!} \#$	Blu $\boxed{x!} \leftarrow$	0 = off (default) (RGB & sync output). 1 = on (blue video & sync output only).
<i>Example:</i>	8*1#	Blu1 \leftarrow	Blue & sync output for setup.
Edge smoothing			
Edge enhancement	$16 * \boxed{x!} \#$	Fil $\boxed{x!} \leftarrow$	0 = off. 1 = on (default).
<i>Example:</i>	16*1#	Fil1 \leftarrow	Enable edge smoothing.
Enhanced mode			
Enhanced mode	$12 * \boxed{x!} \#$	Enh $\boxed{x!} \leftarrow$	0 = off (default). 1 = on.
<i>Example:</i>	12*1#	Enh1 \leftarrow	<i>Example:</i> Enable enhanced mode.
PAL Film mode (2:2 pulldown detection)			
PAL film mode detection	$18 * \boxed{x!} \#$	Flm $\boxed{x!} \leftarrow$	0 = off (default). 1 = on.
<i>Example:</i>	18*1#	Flm1 \leftarrow	<i>Example:</i> Enable PAL film mode detection.

Serial Communication, cont'd

Control Software for Windows

The included Extron USP 405 Control Program for Windows offers another way to control the USP 405 via RS-232 connection in addition to the Simple Instruction Set commands. The control program's graphical interface includes the same functions as those on the signal processor's front panel and some additional features that are only available through the Windows-based software.

The control software is compatible with Windows 95/98, Windows NT, Windows 2000, and Windows XP. Extron's USP 405 Control Program is included with the USP 405, and updates can be downloaded from the Extron Web site (<http://www.extron.com>).

Installing the software

The control program is contained on a CD.

To install the software on the hard drive:

1. Run SETUP.EXE from the CD.
2. Follow the instructions that appear on the screen.

By default the installation creates a C:\USPDDS directory, and it places two icons (USPDDS Control Pgm and USPDDS Help) into a group or folder named "Extron Electronics".

Using the control program

Many items found in the USPDDS Control Program are also accessible via front panel controls and the LCD menus described in chapter 2. Refer to chapter 2 for details on features and settings. The USPDDS Help Program provides information on settings and on how to use the control program itself. These features are described in the sections of this chapter that correspond to the parts of the control program where the features are found.

1. To run the control program, double-click the USPDDS Control Pgm icon in the Extron Electronics group or folder. The Comm menu appears on the screen.



2. Click on the comm port that is connected to the USP 405's RS-232 port. The Extron USPDDS Control Program window appears.

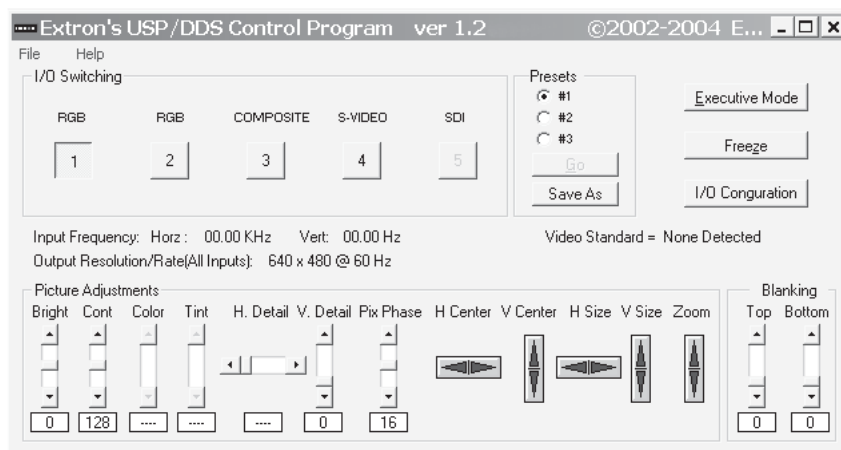

- Click the I/O Config button to configure the inputs from the I/O Configuration Window, shown below.

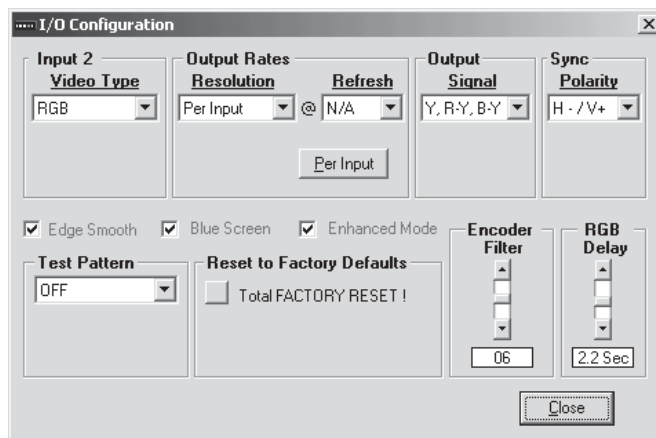

Using the help program

For information on program features, press the F1 computer key, or click on the Help menu from within the USPDDS Control Program, or double-click on the USPDDS Help icon in the Extron Electronics group or folder. 

For explanations of buttons or functions, click the tabs in the help screen to reach the desired screen. Use a mouse or the Tab and Enter keys to select a button/function. A description and tips on using the program appear on screen.

Labeling Buttons on the USP 405

You may wish to customize the labeling of the USP 405's front panel buttons. Premade templates and blank templates for the USP 405's button label windows are included in appendix A of this manual. However, you can easily create, customize, and print labels for the USP's button label windows by using the Button-Label Generator software.

Button-Label Generator software

The Extron Button-Label Generator program (Buttons.exe) is included with the USP 405, and it can also be downloaded from the Extron Web site (<http://www.extron.com>). This program is used to create and print labels that can be inserted into the illuminated pushbuttons or placed in slots above/below buttons on various Extron switchers.

Installing the software

By default, the installation program installs the button label software program in the C:\USPDDS directory, and places the Button-Label Generator icon in the "Extron Electronics" group or folder.

Using the software

- To run the Button-Label Generator program, double-click on the Button-Label Generator icon (shown at left) in the Extron Electronics group or folder, and click OK when prompted.



Serial Communication, cont'd

2. Under *System selection*, choose the System 75C. This selection creates the correctly sized labels for the USP's buttons. The button label editing area changes to reflect the number and arrangement of buttons on the device.
3. Using normal Windows controls, you can create and print labels that can be cut out and placed in the label windows on the front panel of the USP.

For information about using the program, you can access a help file by clicking on the Help menu on the main screen and choosing *Show Help*.

You can also see an example of a completed Extron Button-Label Generator window by clicking on the Help menu on the main screen, choosing *Show Help*, and clicking the Load Demo button.

The following picture shows the Button-Label Generator screen.

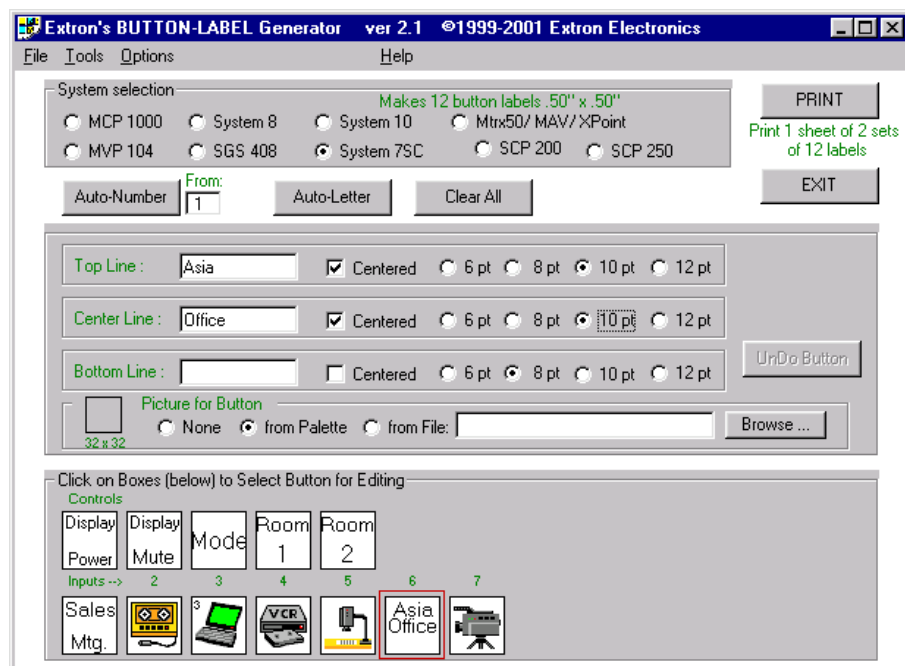

Button label screen

Installing labels in the USP 405's buttons

Use the following procedure to install new labels in the USP 405's front panel buttons.

1. Make new labels by using the Button-Label Generator software (see the previous page). Print them and cut them out.
2. Remove a button from the USP by grasping the button firmly and pulling it away from the front panel.
3. Use a tweaker to gently lever the button cap off of the white backing plate.
4. Insert a button label into the cap and gently but firmly press the cap onto the white backing plate.
5. Press the button into place in the front panel.

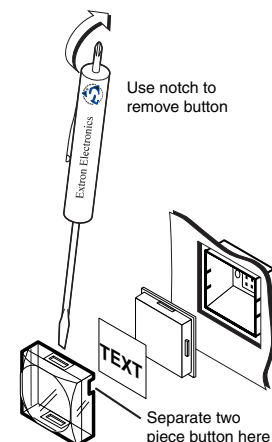

Setting the Output Rate Using the Per Input Feature

Using the Per Input feature, each input (1 through 5) can have a different output rate associated with it. This feature must be initially configured through the USP 405's Control Program for Windows. The initial configuration is stored in memory, and can be recalled whenever the output resolution is set to **Per Input** via either RS-232, the Control Program, or the USP's front panel controls.

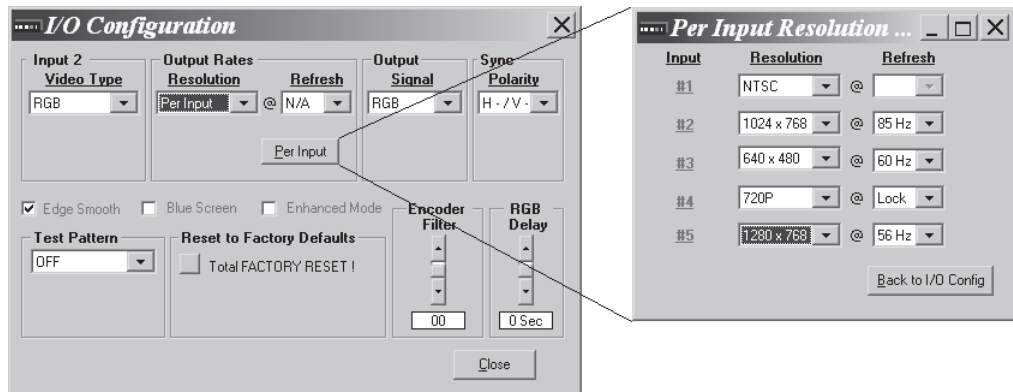

As an example, the Per Input feature can be used in applications where the USP 405 is being used in conjunction with a matrix switcher that has a variety of inputs and outputs. See the example below. This feature allows the USP to automatically upscale/trans-scale/scan convert the input signal, without additional programming.

NOTE Only one process (scaling, trans-scaling, or scan conversion) can occur at one time. For example, you cannot scale and scan convert an input at the same time.

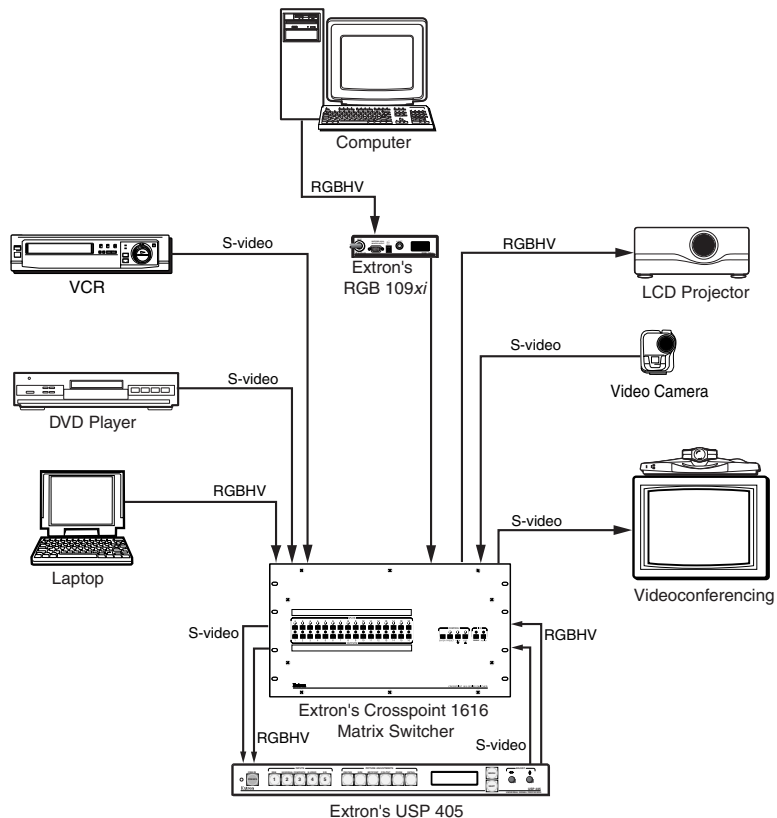

Serial Communication, cont'd



USP 405

A

Appendix

Appendix

Specifications

Part Numbers and Accessories

Firmware Upgrade Installation

Serial Digital Interface (SDI) Card Installation

Appendix

Specifications

Video

Gain	Unity
Crosstalk	-50 dB @ 5 MHz

Video input

Number/signal type	1 RGBHV/RGBS/RGsB computer video with 1 local monitor loop-through 1 RGBHV/RGBS/RGsB, RGBcvS computer video, component video, S-video, or composite video 1 S-video 1 composite video 1 SDI (optional)
Connectors	(2) 15-pin HD female RGB computer video input and loop-through 1 x 5 BNC female RGB computer video, component video, S-video, or composite video input 2 BNC female composite video input and loop-through (2) 4-pin mini DIN female S-video input and loop-through 1 BNC female SDI input (optional)
Nominal level	1 Vp-p for Y of component video and S-video, and for composite video 0.7 Vp-p for RGB and for R-Y and B-Y of component video 0.3 Vp-p for C of S-video
Minimum/maximum levels	Analog: 0.3 V to 2 Vp-p with no offset
Impedance	75 ohms
Horizontal frequency	
Input 1	24 kHz to 100 kHz
Input 2 RGB, HD component video	
.....	24 kHz to 100 kHz
Input 2 RGBS, RGBcvS, component video, S-video, composite video	
.....	15 kHz
Inputs 3 & 4	15 kHz
Input 5	CCIR 601/ITU-R BT.601 (270 Mbps)
Vertical frequency	30 Hz to 120 Hz
Resolution range	Autoscan 640 x 480 to 1600 x 1200
Return loss	<-30 dB @ 5 MHz
DC offset (max. allowable)	0.5 V
External sync (genlock)	0.3 V to 1.0 Vp-p

Video processing

Decoder	9 bit digital
Encoder	10-bit digital
Digital sampling	24 bit, 8 bits per color; 140 MHz
Colors	16.78 million
Horizontal filtering	8 levels
Vertical filtering	8 levels

Video output

Number/signal type	6 RGBHV, RGBS, component video, digital component video (CCIR 601/ ITU-R BT.601), S-video, composite video
--------------------------	---

Connectors	1 x 6 BNC female (RGB, HD component video) (1) 15-pin HD female (RGB, HD component video) 3 BNC female (component video) (1) 4-pin mini DIN (S-video) 1 BNC female (composite video) 1 BNC female (optional SDI digital component video)
Nominal level	1 Vp-p for Y of component video and S-video, and for composite video 0.7 Vp-p for RGB and for R-Y and B-Y of component video 0.3 Vp-p for C of S-video
Minimum/maximum levels	0 V to 2.0 Vp-p
Impedance	75 ohms
Scaled resolutions	640x480 ^{1,3,4,6} , 800x600 ^{1,3,4,6} , 832x624 ^{3,4,6} , 848x480 ^{3,6} , 852x480 ^{3,6} , 1024x768 ^{1,3,4,5,6} , 1280x768 ^{2,6} , 1280x1024 ^{1,3,6} , 1360x765 ^{3,6} , 1365x1024 ^{3,6} , 1400x1050 ^{1,3,6} , 576p ^{1,6} , 720p ^{3,6} , 1080p ^{3,6} , 1080i ^{1,3,6} , NTSC, PAL ¹ = at 50 Hz ² = at 56 Hz ³ = at 60 Hz ⁴ = at 75 Hz ⁵ = at 85 Hz ⁶ = locked to the current input's vertical refresh rate (up to 60 Hz) (Accu-RATE Frame Lock)
Return loss	-30 dB @ 5 MHz
DC offset	These data are for output with input at 0 offset: ±25 mV maximum for RGB 350±25 mV maximum for Y of component video/S-video, composite video 650±25 mV maximum for R-Y & B-Y of component video, C of S-video
Switching type	Triple-Action

Sync

Input type	Autodetect RGBHV, RGBS, RGsB
Output type	RGBHV, RGBS
Standards	NTSC 3.58, NTSC 4.43, PAL, and SECAM
Input level	0 V to 5 Vp-p
Output level	0 V to 5 Vp-p, unterminated
Input impedance	510 ohms
Output impedance	75 ohms
Max input voltage	5 Vp-p
Polarity	Positive or negative (selectable)

Control/remote — switcher/scaler

Serial control port	RS-232, 9-pin female D connector
Baud rate and protocol	9600 baud, 8 data bits, 1 stop bit, no parity
Serial control pin configurations	2 = TX, 3 = RX, 5 = GND
Contact closure	9-pin female D connector
Contact closure pin configurations	1 = input 1, 4 = input 2, 6 = input 3, 7 = input 4, 8 = input 5
IR controller module	IR 801 (optional)
Program control	Extron's control program for Windows® Extron's Simple Instruction Set (SIS™)

General

Power	100 VAC to 240 VAC, 50/60 Hz, 30 watts, internal, autoswitchable
Temperature/humidity	Storage: -40 to +158 °F (-40 to +70 °C) / 10% to 90%, noncondensing Operating: +3° to +122 °F (0 to +50 °C) / 10% to 90%, noncondensing
Rack mount	Yes
Enclosure type	Metal
Enclosure dimensions	1.8" H x 17.5" W x 12" D (1U high, full rack wide) 4.6 cm H x 44.4 cm W x 30.5 cm D (Depth excludes connectors and knobs. Width excludes rack ears.)

Appendix, cont'd

Product weight

USP 405	6.3 lbs (2.9 kg)
USP 405, SDI input	6.4 lbs (2.9 kg)
USP 405, SDI output	6.5 lbs (2.9 kg)
USP 405, SDI in & output	6.9 lbs (3.1 kg)

Shipping weight

USP405 w/SDI in & output	12 lbs (6 kg)
All other models	11 lbs (5 kg)

Vibration ISTA 1A in carton (International Safe Transit Association)

Listings UL, CUL

Compliances CE, FCC Class A

MTBF 30,000 hours

Warranty 3 years parts and labor

NOTE All nominal levels are at $\pm 10\%$.

NOTE Specifications are subject to change without notice.

Part Numbers and Accessories

Included parts

These items are included in each order for a USP 405:

Included parts	Part number
USP 405	60-369-01
or USP 405 with SDI Input	60-369-02
or USP 405 with SDI Output	60-369-03
or USP 405 with SDI Input and Output	60-369-04
& Rubber feet (self-adhesive) (4)	25-020-02
& Rack and through-desk mounting kit	70-077-03
& IEC power cord	
& Tweezer (small screwdriver)	
& USP 405 User's Manual	
& USP 405 Windows-based control program	

Accessories

These items can be ordered separately:

Accessories	Part number
IR 801 remote control	70-153-01
SDI video input card	70-168-01
SDI video output card	70-065-01

Firmware Upgrade Installation

In some cases the USP 405's firmware may require replacement with an updated version. There are four user-replaceable firmware chips: U60 — the main microcontroller, U24, U67 and U68. Both U67 and U68 are replaced as a pair. The numbers are printed on the circuit board. We recommend that you send the unit in to Extron for service and updates.

CAUTION *Changes to firmware must be performed by authorized service personnel only. Some USP 405 firmware updates must be performed at the Extron factory.*

Follow these steps to replace firmware in the USP 405:

1. Disconnect the AC power cord from the USP 405 to remove power from the unit.

WARNING *To prevent electric shock, always unplug the USP 405 from the AC power source before opening the enclosure.*

2. Remove the USP 405 from the rack or furniture.
3. Remove the cover of the USP (the top half of the enclosure) by removing the screws, then lifting the cover straight up.

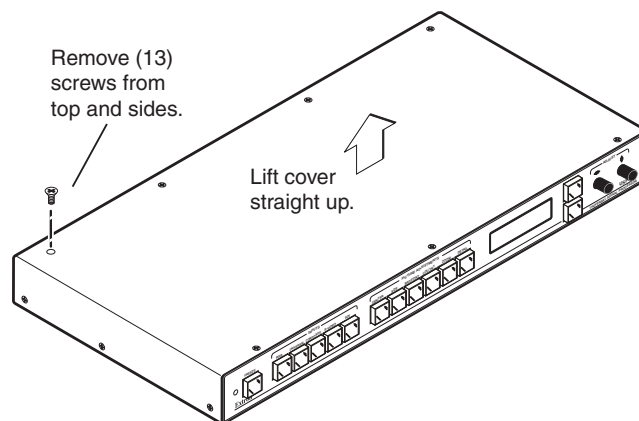

Removing the USP 405 cover

CAUTION *Do not touch any switches or other electronic components inside the USP 405. Doing so could damage the unit. Electrostatic discharge (ESD) can damage IC chips even though you cannot feel it. You must be electrically grounded before proceeding with firmware replacement. A grounding wrist strap is recommended.*

4. Locate the firmware chip(s) to be replaced on the circuit board, as shown in the following picture.

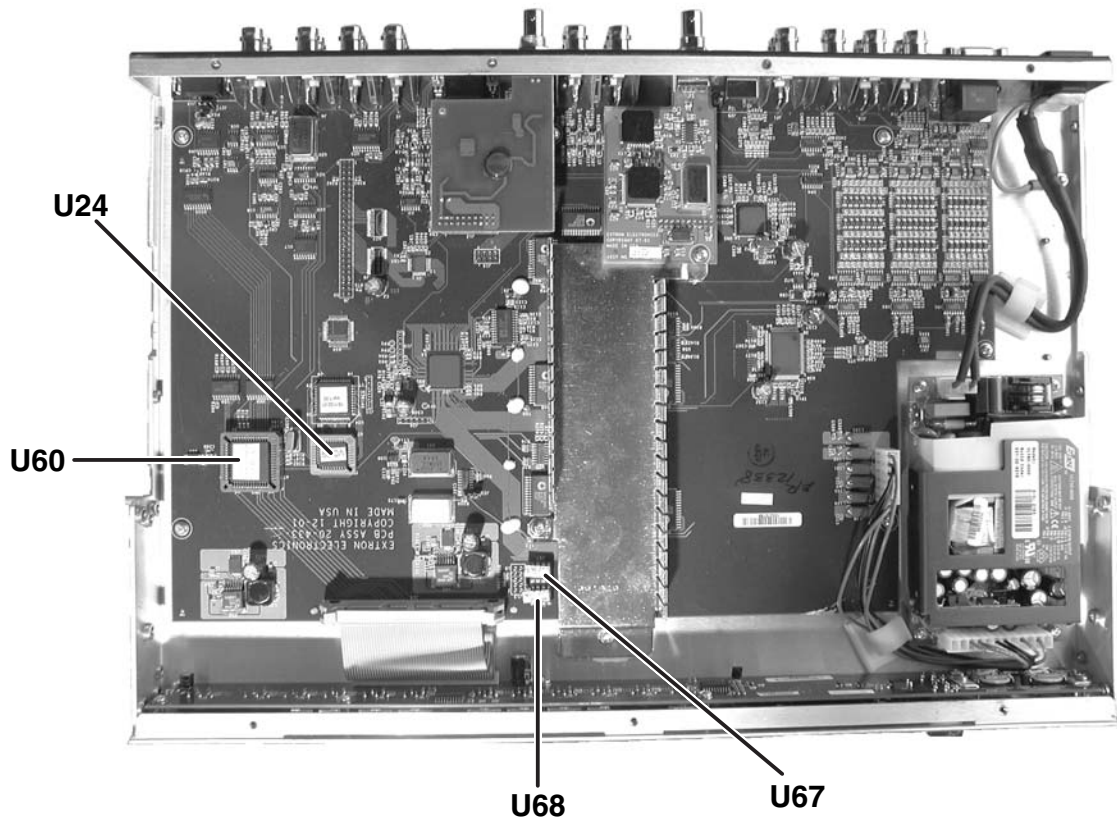

Locating the four firmware IC chips

- After you are electrically grounded, the U67 and U68 IC chips (which must be replaced as a pair) may be removed by grasping each chip firmly with your fingers and pulling it out, then continuing to step 8.

Removal of the U60 and U24 IC chips requires a PLCC IC puller tool. To remove either chip, align the hooks of a PLCC IC puller tool with the slots located in opposite ends of the firmware chip.

- Insert the hooks into the slots, and squeeze the tool gently to grasp the chip.
- Pull the chip straight out of the socket, and set it aside.
- For U67 and U68**, align the slots of the new firmware chip with the notches of the socket in the same orientation as the old chip. Gently, but firmly, press the chip into place in the socket.

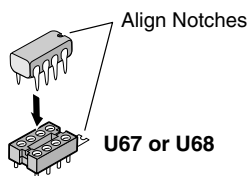
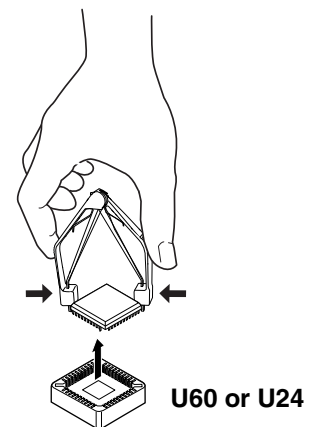

- For U60 and U24**, note the key (angled corner) of the new firmware IC and the dot on the underside that indicates pin 1. Orient the IC to match the key and pin 1 (indicated by arrow) on the socket, and gently, but firmly, press the IC into place.

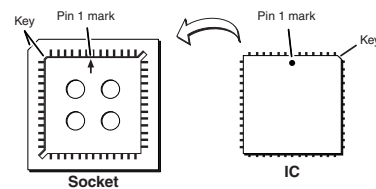

10. Replace the top cover on the USP 405, and fasten it with the screws that were removed in step 3.
11. Rack or furniture mount the scaler, and reconnect the AC power cord.

Serial Digital Interface (SDI) Card Installation

The optional SDI input and output cards may be installed in the USP 405 if it does not already have an input or output for a serial digital interface signal. We recommend that you send the unit to Extron for service and updates. The following picture shows the USP 405 with both input and output SDI cards installed.

WARNING Changes to electronic components must be performed by authorized service personnel only.

Follow these steps to install an SDI card in the USP 405:

1. Disconnect the AC power cord from the USP 405 to remove power.

WARNING To prevent electric shock, always unplug the USP from the AC power source before opening the enclosure.

2. Remove the USP from the rack or furniture.
3. Remove the cover of the USP 405 (the top half of the enclosure) by removing the screws, then lifting the cover straight up. See the top cover removal diagram in the previous “Firmware Upgrade Installation” section.

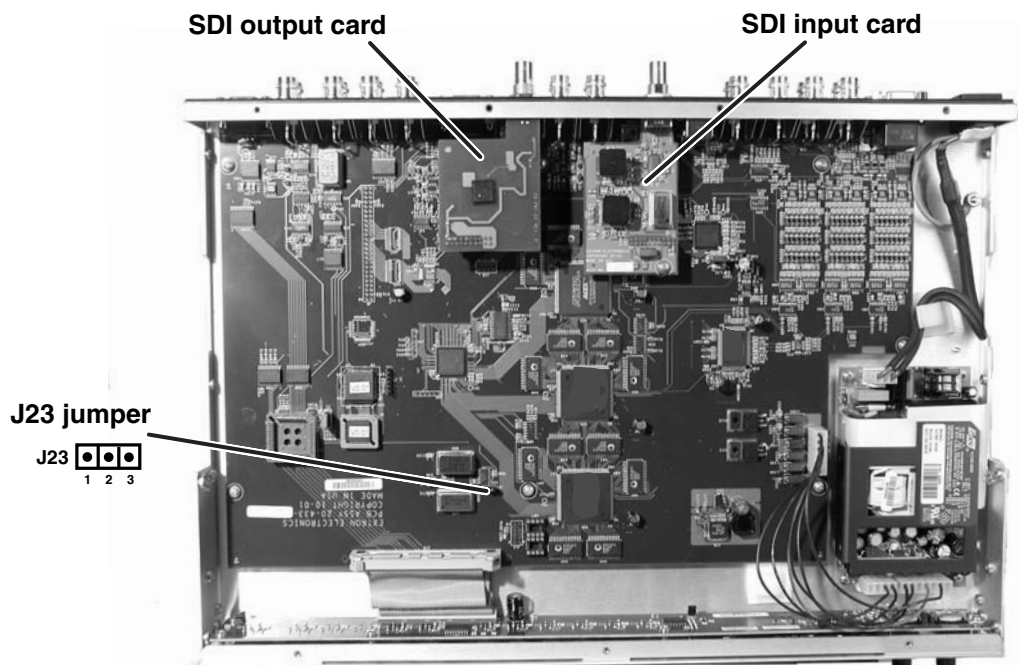

Both SDI cards installed

CAUTION Do not touch any switches or other electronic components inside the USP 405. Doing so could damage the USP. Electrostatic discharge (ESD) can damage IC chips even though you cannot feel it. You must be electrically grounded before proceeding with any electronic component replacement. A grounding wrist strap is recommended.

Appendix, cont'd

4. If installing the SDI input card, locate the SDI input card standoff situated near the middle rear portion of the main circuit board (looking from above with the front panel nearest to you). See the following picture.

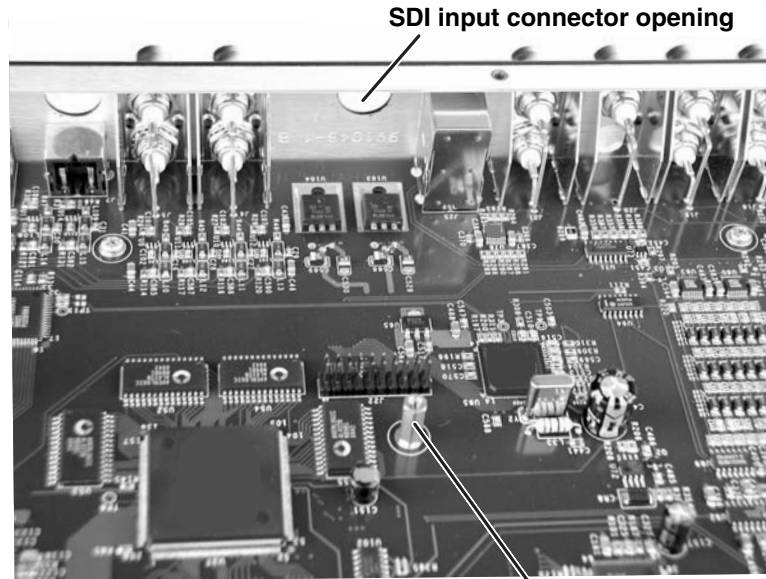

SDI input card standoff
SDI input card standoff

If installing the SDI output card, locate the SDI output card connector opening situated near the middle rear portion of the main circuit board (looking from above with the front panel nearest to you). See the following picture.

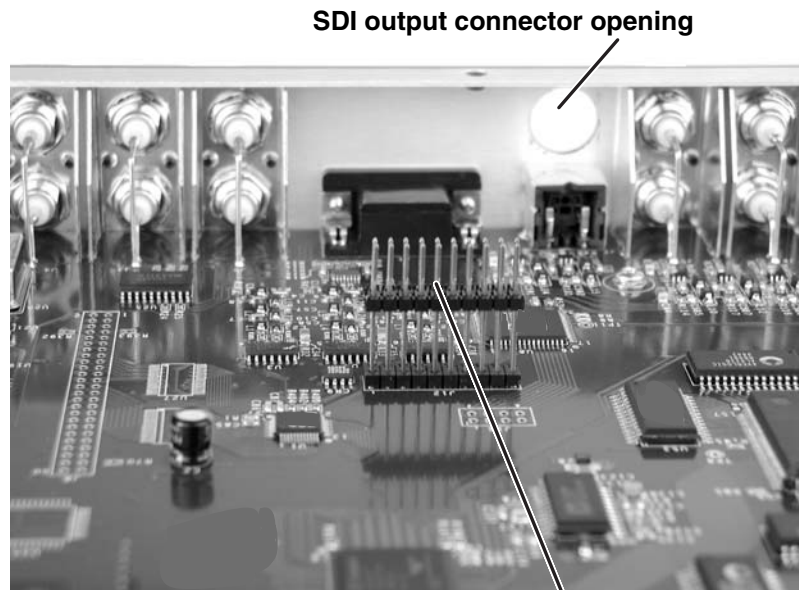

20-pin connector for SDI output card
SDI output card circuit board connector

5. If the rear panel SDI connector opening is still covered, remove the plastic cover and position the SDI card at an angle with the SDI connector protruding from the rear SDI connector opening.
6. The SDI input card has a 20-pin socket on the underside that should align with the 20 pins on the main circuit board. Be sure to align the pins properly, in order to prevent bending the pins, before pressing the SDI card firmly in place against the standoff. The mounting hole on the SDI card should now be directly over the standoff. See the picture below.

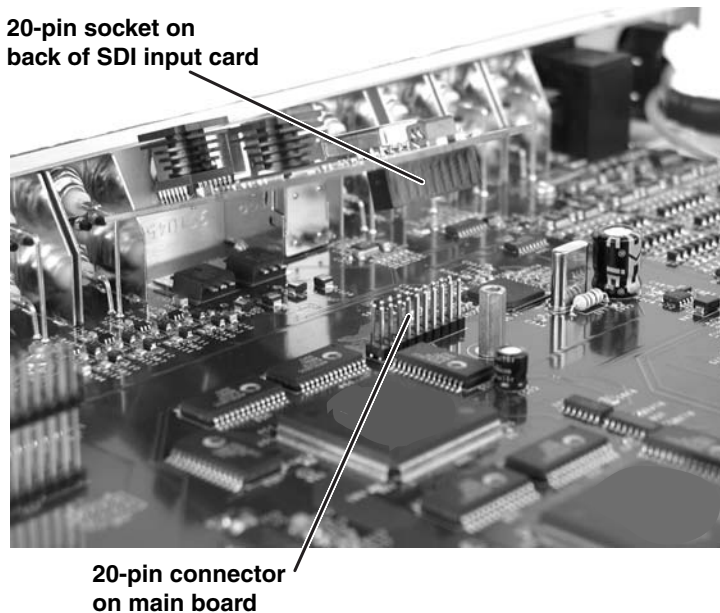

Input SDI board installation

The SDI output card has a 20-pin socket on the underside which should align with the 20 pins on the main circuit board. Be sure to align the pins properly, in order to prevent bending the pins, before pressing the SDI card firmly in place. See the picture below.

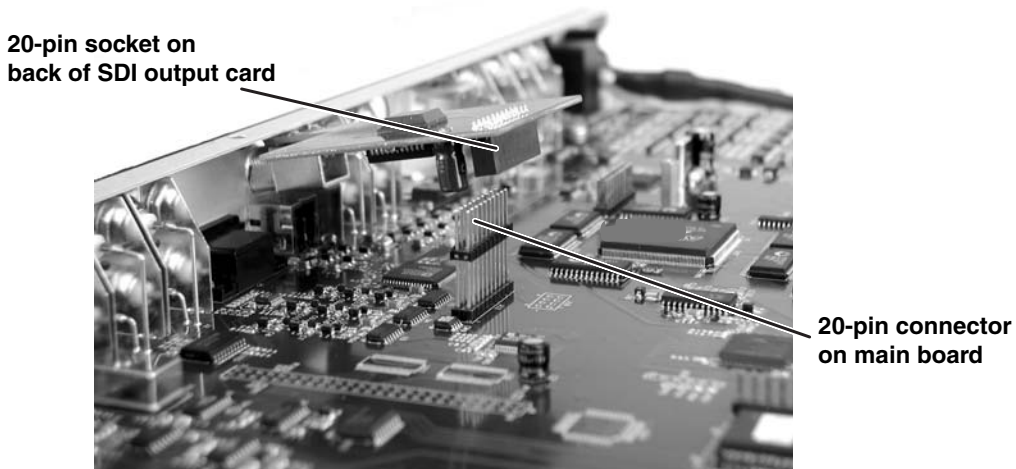

Output SDI board installation

Appendix, cont'd

7. For the SDI input card installation, insert the card's installation screw through the SDI card's mounting hole and gently tighten it into the standoff. See the picture below.



Installed SDI input card

For the SDI output card installation, the card should be positioned in place as shown below.

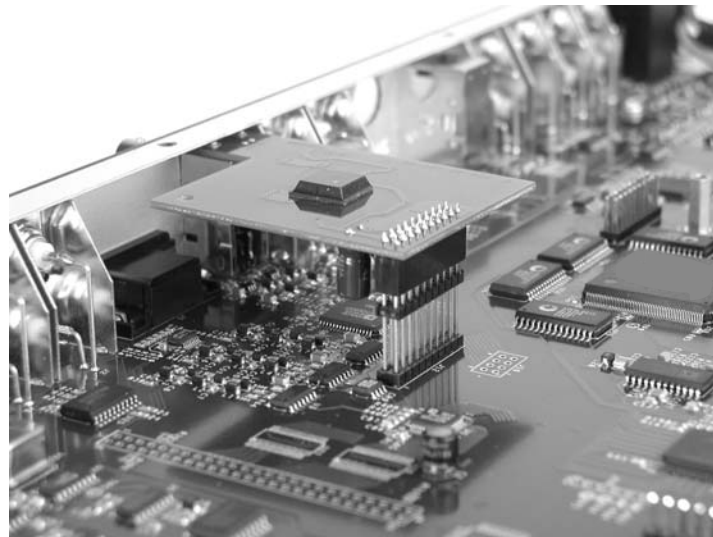

Installed SDI output card

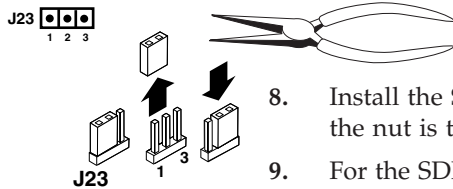

8. Install the SDI connector's hex nut and keep the SDI card from twisting as the nut is tightened.
9. For the SDI input card installation, move the jumper on J23 (see the illustration on page A-7) from pins 1 and 2 (no SDI input card present) to pins 2 and 3 (SDI input card present).
10. Replace the top cover on the USP, and fasten it with the screws that were removed in step 3.
11. Rack or furniture mount the USP 405, and reconnect the AC power cord.

FCC Class A Notice

Note: This equipment has been tested and found to comply with the limits for a Class A digital device, pursuant to part 15 of the FCC Rules. These limits are designed to provide reasonable protection against harmful interference when the equipment is operated in a commercial environment. This equipment generates, uses and can radiate radio frequency energy and, if not installed and used in accordance with the instruction manual, may cause harmful interference to radio communications. Operation of this equipment in a residential area is likely to cause harmful interference, in which case the user will be required to correct the interference at his own expense.

Note: This unit was tested with shielded cables on the peripheral devices. Shielded cables must be used with the unit to ensure compliance.

Extron's Warranty

Extron Electronics warrants this product against defects in materials and workmanship for a period of three years from the date of purchase. In the event of malfunction during the warranty period attributable directly to faulty workmanship and/or materials, Extron Electronics will, at its option, repair or replace said products or components, to whatever extent it shall deem necessary to restore said product to proper operating condition, provided that it is returned within the warranty period, with proof of purchase and description of malfunction to:

**USA, Canada, South America,
and Central America:**

Extron Electronics
1230 South Lewis Street
Anaheim, CA 92805, USA

Asia:

Extron Electronics, Asia
135 Joo Seng Road, #04-01
PM Industrial Bldg.
Singapore 368363

Europe, Africa, and the Middle East:

Extron Electronics, Europe
Beeldschemweg 6C
3821 AH Amersfoort
The Netherlands

Japan:

Extron Electronics, Japan
Kyodo Building
16 Ichibancho
Chiyoda-ku, Tokyo 102-0082
Japan

This Limited Warranty does not apply if the fault has been caused by misuse, improper handling care, electrical or mechanical abuse, abnormal operating conditions or non-Extron authorized modification to the product.

If it has been determined that the product is defective, please call Extron and ask for an Applications Engineer at (714) 491-1500 (USA), 31.33.453.4040 (Europe), 65.6383.4400 (Asia), or 81.3.3511.7655 (Japan) to receive an RA# (Return Authorization number). This will begin the repair process as quickly as possible.

Units must be returned insured, with shipping charges prepaid. If not insured, you assume the risk of loss or damage during shipment. Returned units must include the serial number and a description of the problem, as well as the name of the person to contact in case there are any questions.

Extron Electronics makes no further warranties either expressed or implied with respect to the product and its quality, performance, merchantability, or fitness for any particular use. In no event will Extron Electronics be liable for direct, indirect, or consequential damages resulting from any defect in this product even if Extron Electronics has been advised of such damage.

Please note that laws vary from state to state and country to country, and that some provisions of this warranty may not apply to you.



Extron Electronics, USA
1230 South Lewis Street
Anaheim, CA 92805
USA
714.491.1500
Fax 714.491.1517

Extron Electronics, Europe
Beeldschermweg 6C
3821 AH Amersfoort
The Netherlands
+31.33.453.4040
Fax +31.33.453.4050

Extron Electronics, Asia
135 Joo Seng Road, #04-01
PM Industrial Building
Singapore 368363
+65.6383.4400
Fax +65.6383.4664

Extron Electronics, Japan
Kyodo Building
16 Ichibancho
Chiyoda-ku, Tokyo 102-0082 Japan
+81.3.3511.7655
Fax +81.3.3511.7656